

JVC



English

中文

AUDIO / VIDEO CONTROL RECEIVER

AV功率放大器（带收音）

RX-D201S

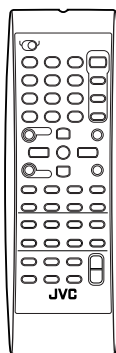
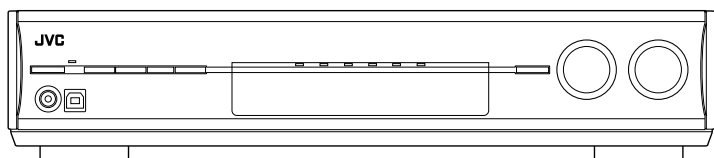

AV COMPU LINK

INSTRUCTIONS

使用说明书

Warnings, Cautions, and Others

警告，注意及其他须知事项

Caution—/I STANDBY/ON button!

Disconnect the mains plug to shut the power off completely. The /I STANDBY/ON button in any position does not disconnect the mains line. The power can be remote controlled.

注意—/I STANDBY/ON 开关!

想要完全关闭电源，须将电源插头从插座上拔下。无论 /I STANDBY/ON 键处于何种位置，主电路仍旧没有关闭。电源开关可用遥控器进行控制。

CAUTION

To reduce the risk of electrical shocks, fire, etc.:

1. Do not remove screws, covers or cabinet.
2. Do not expose this appliance to rain or moisture.

注意

为了减少触电，火灾等危险：

1. 请勿擅自卸下螺丝钉，盖子或机壳。
2. 请勿让本机受雨淋或置潮湿环境中。

CAUTION

- Do not block the ventilation openings or holes. (If the ventilation openings or holes are blocked by a newspaper or cloth, etc., the heat may not be able to get out.)
- Do not place any naked flame sources, such as lighted candles, on the apparatus.
- When discarding batteries, environmental problems must be considered and local rules or laws governing the disposal of these batteries must be followed strictly.
- Do not expose this apparatus to rain, moisture, dripping or splashing and that no objects filled with liquids such as vases, shall be placed on the apparatus.

注意

- 切勿堵塞通风眼或孔。
(如果通风眼或孔被报纸或布等物堵塞，热量将无法散出。)
- 切勿在机体上放置任何裸露的火源，如点燃的蜡烛。
- 想要丢弃电池时，必须考虑环保问题以及严格遵守当地关于处理废旧电池的有关法律规定或条例。
- 切勿让本机受雨淋，受潮湿，落下或溅上水滴；亦勿在机体的上面放置盛满液体的容器，如花瓶。

Caution: Proper Ventilation

To avoid risk of electric shock and fire and to protect from damage. Locate the apparatus as follows:

- Front: No obstructions open spacing.
Sides: No obstructions in 10 cm from the sides.
Top: No obstructions in 10 cm from the top.
Back: No obstructions in 15 cm from the back.
Bottom: No obstructions, place on the level surface.

In addition, maintain the best possible air circulation as illustrated.

注意：正确的通风方法

为了防止触电、火灾以及避免损坏，按如下要求放置机器：

- 前面：留下空间不要放置障碍物。
侧面：侧面的10 cm之内不要放置障碍物。
上面：上面的10 cm之内不要放置障碍物。
背面：背面的15 cm之内不要放置障碍物。
底部：不要放置障碍物，水平放置。

此外，如图所示，尽可能保持最佳的空气循环。

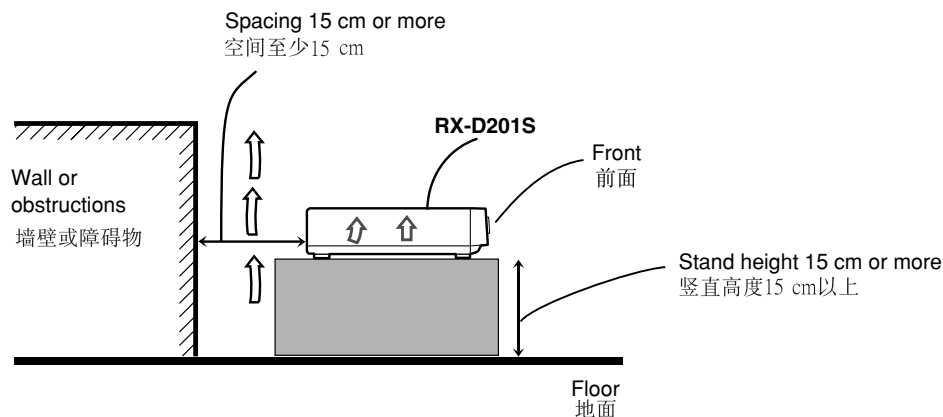
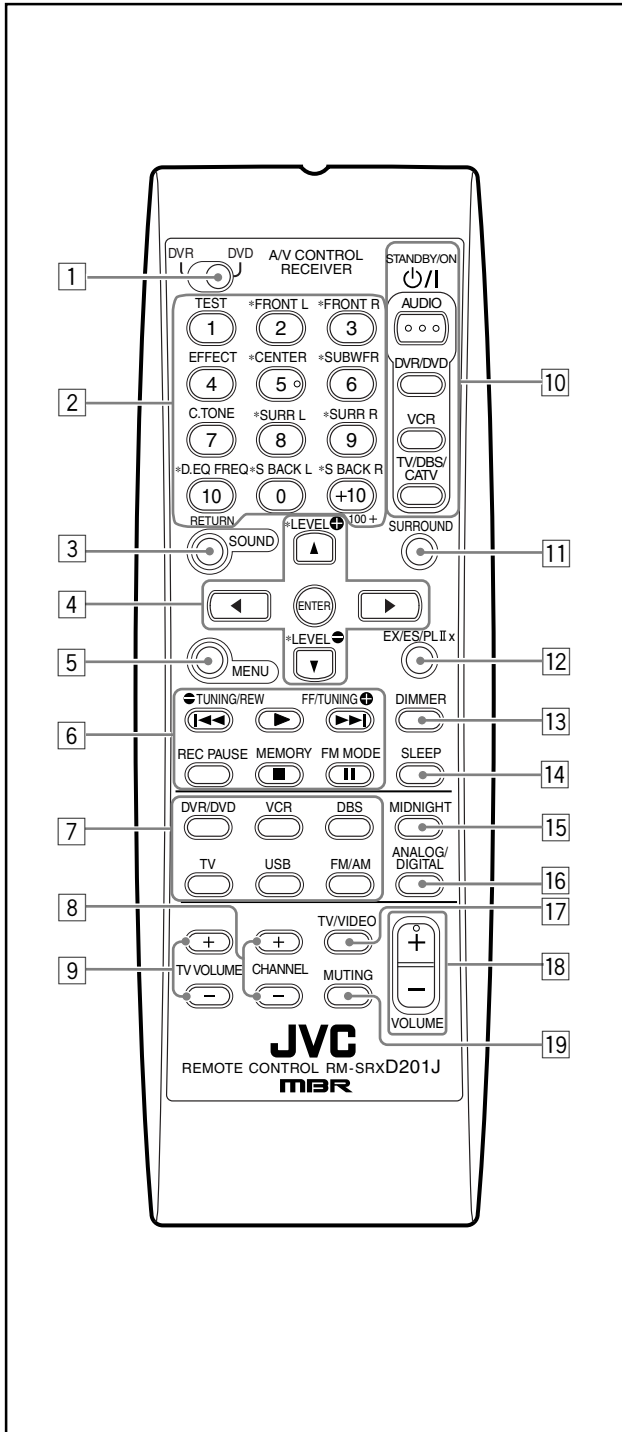

Table of Contents

Parts identification	2
Getting started	4
Before Installation	4
Checking the supplied accessories	4
Putting batteries in the remote control	4
Setting the voltage selector	4
Connecting the FM and AM antennas	5
Connecting the speakers	6
Connecting video components	7
USB connection	10
Connecting the power cord	11
Basic operations	12
1 Turn on the power	12
2 Select the source to play	12
3 Adjust the volume	13
Turning off the sounds temporarily	14
Changing the display brightness	14
Turning off the power with the Sleep Timer	14
Basic settings	15
Setting the speaker information easily	
—Quick Speaker Setup	15
Basic setting items	16
Operating procedure	17
Setting the speakers	17
Activating the EX/ES/PLIIx setting—EX/ES/PLIIx	18
Selecting the main or sub channel—DUAL MONO	19
Setting bass sound	19
Using the Midnight mode—MIDNIGHT MODE	19
Setting the digital input (DIGITAL IN) terminals	
—DIGITAL IN 1/2	20
Selecting the component video input mode	
—DVD VIDEO IN/VCR VIDEO IN/DBS VIDEO IN	20
Sound adjustments	21
Basic adjustment items	21
Operating procedure	21
Adjusting the speaker output levels	22
Adjusting the equalization patterns	
—D EQ 63Hz/250Hz/1kHz/4kHz/16kHz	22
Adjusting the bass sounds	23
Adjusting the sound parameters for the	
Surround/DSP modes	23
Tuner operations	25
Setting the AM tuner interval spacing	25
Tuning in to stations manually	25
Using preset tuning	25
Selecting the FM reception mode	26
Creating realistic sound fields	27
Reproducing theater ambience	27
Introducing the Surround modes	27
Introducing the DSP modes	29
Using the Surround/DSP modes	30
Activating the Surround/DSP modes	31
AV COMPU LINK remote control system	32
Operating other JVC products	34
Operating other manufacturers' products	36
Troubleshooting	39
Specifications	40

Parts identification



Remote control

See pages in parentheses for details.

- 1 DVR/DVD mode selector (35, 38)
- 2 • Numeric buttons (26, 34 – 38)
1 – 10, 0, +10, 100+
• Adjusting buttons for speaker and subwoofer output level and sound adjustment (22)
TEST, FRONT L, FRONT R, EFFECT, CENTER, SUBWFR, C. TONE, SURR L, SURR R, D. EQ FREQ, S BACK L, S BACK R
• RETURN button (34)
- 3 SOUND button (22 – 24)
- 4 • Operating buttons for DVD recorder or DVD player*
cursor buttons (▶, ◀, ▲, ▼), ENTER (35, 38)
• Adjusting buttons for speakers and subwoofer output level and D. EQ FREQ level (22)
LEVEL ◀, LEVEL ▶
- 5 MENU button for DVD recorder or DVD player* (35, 38)
- 6 • Operating buttons for video components (34, 35, 37, 38)
◀◀, ▶▶, ■, ■, ■, REW, FF, REC PAUSE
• Operating buttons for tuner (25, 26)
◀ TUNING, TUNING ▶, MEMORY, FM MODE
- 7 Source selecting buttons (12, 25, 26, 34 – 38)
DVR/DVD, VCR, DBS, TV, USB, FM/AM
- 8 CHANNEL +/- buttons (34 – 38)
- 9 TV VOLUME +/- buttons (34, 36)
- 10 STANDBY/ON ◀/▶ buttons (12, 34 – 38)
AUDIO, DVR/DVD, VCR, TV/DBS/CATV
- 11 SURROUND button (31)
- 12 EX/ES/PLIIx button (18)
- 13 DIMMER button (14)
- 14 SLEEP button (14)
- 15 MIDNIGHT button (19)
- 16 ANALOG/DIGITAL button (12)
- 17 TV/VIDEO button (34, 36)
- 18 VOLUME +/- button (13)
- 19 MUTING button (14)

* These buttons can be used for operating a JVC DVD recorder or DVD player with the mode selector set to “DVR” or “DVD” (see page 35).

If these buttons do not function normally, use the remote control supplied with your DVD recorder or DVD player. Refer also to the manuals supplied with the DVD recorder or DVD player for details.

• When operating a DVD recorder (for JVC products ONLY), set the mode selector (1) to “DVR.”

• When operating a DVD player, set the mode selector (1) to “DVD.”

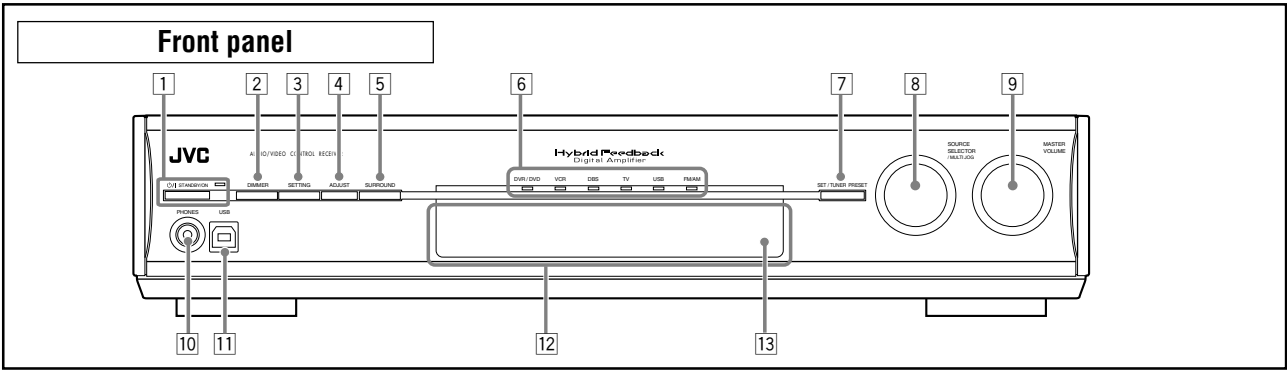

- | | |
|--|---|
| <ul style="list-style-type: none"> 1 ⏻/I STANDBY/ON button and standby lamp (12, 25) 2 DIMMER button (14) 3 SETTING button (15, 17, 25) 4 ADJUST button (21, 25) 5 SURROUND button (31) 6 Source lamps
DVR/DVD, VCR, DBS, TV, USB, FM/AM 7 • SET button (15, 17, 21)
• TUNER PRESET button (26) | <ul style="list-style-type: none"> 8 • SOURCE SELECTOR (12, 26)
• MULTI JOG (15, 17, 21, 26, 31) 9 MASTER VOLUME control (13) 10 PHONES jack (13) 11 USB terminal (10) 12 Display window (see below) 13 Remote sensor (4) |
|--|---|

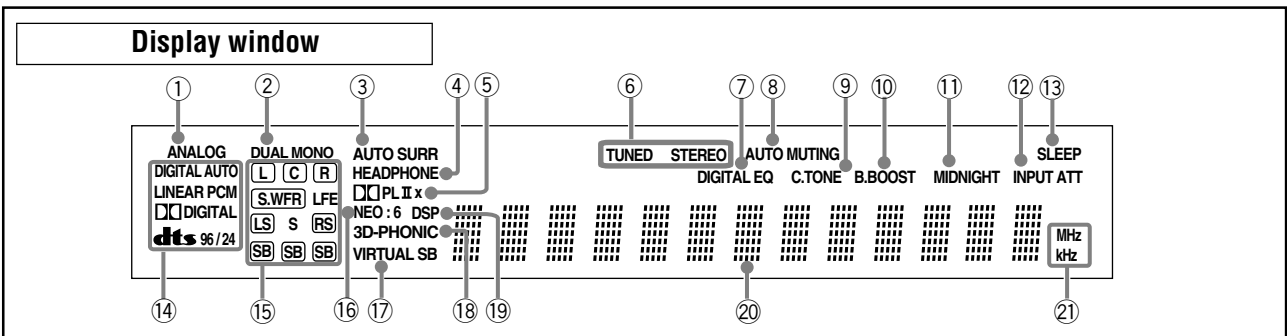

- | | |
|--|---|
| <ul style="list-style-type: none"> 1 ANALOG indicator (13) 2 DUAL MONO indicator (19) 3 AUTO SURR (surround) indicator (31) 4 HEADPHONE indicator (13, 28) 5 $\square\square$ PL II and $\square\square$ PL IIx indicator (27 – 29) 6 Tuner operation indicators (25)
TUNED, STEREO 7 DIGITAL EQ indicator (22) 8 AUTO MUTING indicator (26) 9 C.TONE indicator (24) 10 B.BOOST indicator (23) 11 MIDNIGHT indicator (19) | <ul style="list-style-type: none"> 12 INPUT ATT (attenuate) indicator (23) 13 SLEEP indicator (14) 14 Digital signal format indicators (13, 27, 28)
DIGITAL AUTO, LINEAR PCM, $\square\square$ DIGITAL, dts, 96/24 15 Signal and speaker indicators (14) 16 NEO:6 indicator (28) 17 VIRTUAL SB indicator (30) 18 3D-PHONIC indicator (28, 29) 19 DSP indicator (28, 29) 20 Main display 21 Frequency unit indicators
MHz (for FM stations), kHz (for AM stations) |
|--|---|

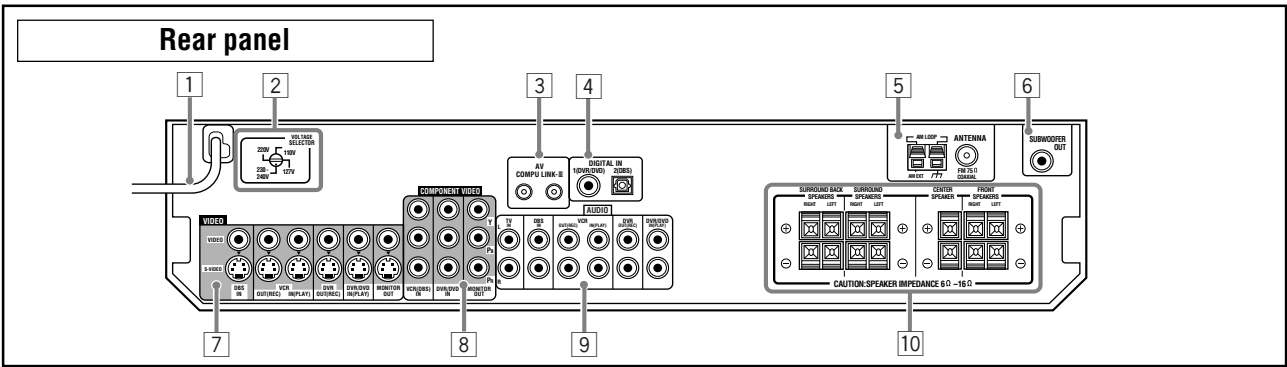

- | | |
|---|---|
| <ul style="list-style-type: none"> 1 Power cord (11) 2 VOLTAGE SELECTOR (4) 3 AV COMPU LINK-III terminals (32) 4 DIGITAL IN terminals (10)
• Coaxial: 1(DVR/DVD)
• Optical: 2(DBS) 5 ANTENNA terminals (5) 6 SUBWOOFER OUT jack (6) | <ul style="list-style-type: none"> 7 VIDEO jacks (7 – 9)
VIDEO (composite video) jacks, S-VIDEO jacks
• Input: DBS IN, VCR IN (PLAY), DVR/DVD IN (PLAY)
• Output: VCR OUT (REC), DVR OUT (REC), MONITOR OUT 8 COMPONENT VIDEO (Y, Pb, Pr) jacks (7 – 9)
VCR (DBS) IN, DVR/DVD IN, MONITOR OUT 9 AUDIO jacks (7 – 9)
• Input: TV IN, DBS IN, VCR IN (PLAY), DVR/DVD IN (PLAY)
• Output: VCR OUT (REC), DVR OUT (REC) 10 Speakers terminals (6)
SURROUND BACK SPEAKERS, SURROUND SPEAKERS,
CENTER SPEAKER, FRONT SPEAKERS |
|---|---|

Getting started

Before Installation

General precautions

- Be sure your hands are dry.
- Turn the power off to all components.
- Read the manuals supplied with the components you are going to connect.

Locations

- Install the receiver in a location that is level and protected from moisture and dust.
- The temperature around the receiver must be between -5°C and 35°C .
- Make sure there is good ventilation around the receiver. Poor ventilation could cause overheating and damage the receiver.
- Leave sufficient distance between the receiver and the TV.

Handling the receiver

- Do not insert any metal object into the receiver.
- Do not disassemble the receiver or remove screws, covers, or cabinet.
- Do not expose the receiver to rain or moisture.
- Do not pull on the power cord to unplug the cord. When unplugging the cord, always grasp the plug so as not to damage the cord.
- When you are away on travel or otherwise for an extended period or time, remove the plug from the wall outlet. A small amount of power is always consumed while the power cord is connected to the wall outlet.

The receiver has a built-in cooling fan which operates while the receiver is turned on. Be sure to leave enough ventilation to obtain sufficient cooling effect.

CAUTION:

Do not connect the AC power plug to the wall outlet until all connections are completed.

Checking the supplied accessories

Check to be sure you have all of the following supplied accessories. If anything is missing, contact your dealer immediately.

- Remote control (× 1)
- Batteries (× 2)
- AM loop antenna (× 1)
- FM antenna (× 1)
- AC plug adaptor (× 1)

Putting batteries in the remote control

Before using the remote control, put two supplied batteries first.

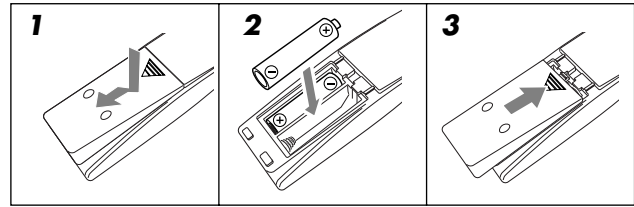

1 Press and slide the battery cover on the back of the remote control.

2 Insert batteries.

Make sure to match the polarity: (+) to (+) and (-) to (-).

3 Replace the cover.

If the range or effectiveness of the remote control decreases, replace the batteries. Use two R6(SUM-3)/AA(15F) type dry-cell batteries.

- Supplied batteries are for initial setup. Replace for continued use.

CAUTION:

Follow these precautions to avoid leaking or cracking cells:

- Place batteries in the remote control so they match the polarity: (+) to (+) and (-) to (-).
- Use the correct type of batteries. Batteries that look similar may differ in voltage.
- Always replace both batteries at the same time.
- Do not expose batteries to heat or flame.

When using the remote control, aim the remote control directly at the remote sensor on the front panel.

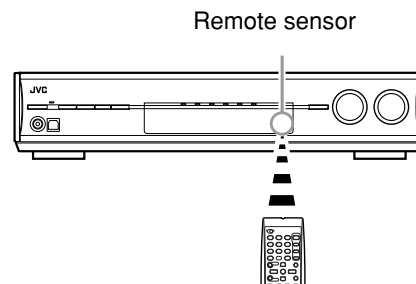

Setting the voltage selector

Before connections, always do the following first if necessary.

Select the correct voltage in **VOLTAGE SELECTOR** on the rear of the receiver by using a screw driver.

- Check to be sure if the voltage mark is set to the voltage for your area where this unit plugs in.

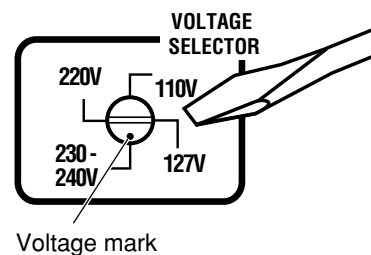

Connecting the FM and AM antennas

Do not connect the AC power plug to the wall outlet until all connections are completed.

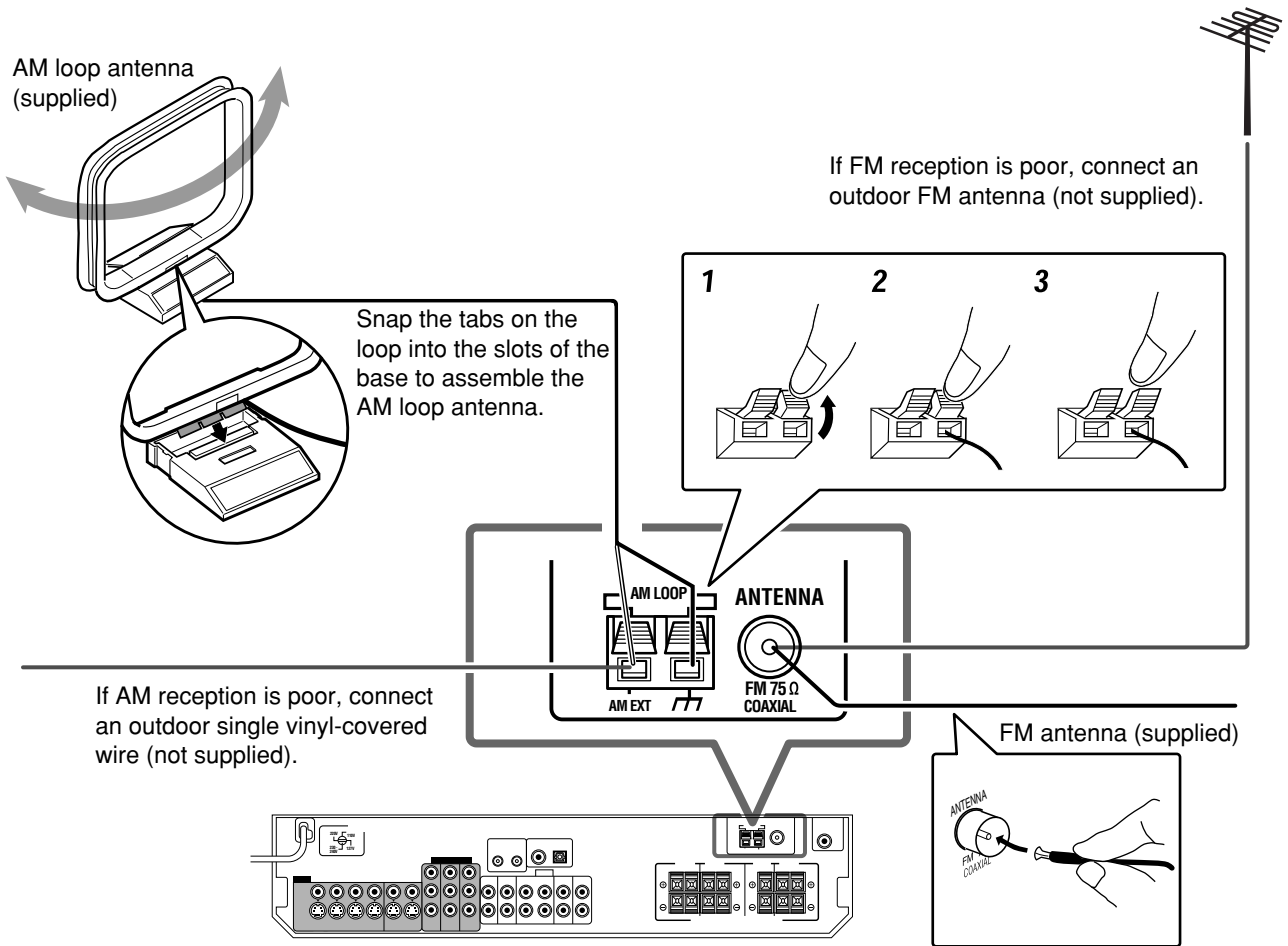

AM antenna connection

Connect the AM loop antenna supplied to the AM LOOP terminals. Connect the white cord to the AM EXT terminal, and connect the black cord to the \uparrow terminal. Turn the loop until you have the best reception.

- If the reception is poor, connect an outdoor single vinyl-covered wire (not supplied) to the AM EXT terminal. Keep the AM loop antenna connected.

FM antenna connection

Connect the FM antenna supplied to the FM 75 Ω COAXIAL terminal as a temporary measure. Extend the supplied FM antenna horizontally.

- If the reception is poor, connect an outdoor FM antenna (not supplied). Before attaching a 75 Ω coaxial cable with a connector (IEC or DIN 45325), disconnect the supplied FM antenna.

NOTES

- If the AM loop antenna wire is covered with vinyl, remove the vinyl while twisting it as shown on the right.
- Make sure the antenna conductors do not touch any other terminals, connecting cords and power cord. This could cause poor reception.

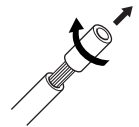

Connecting the speakers

Do not connect the AC power plug to the wall outlet until all connections are completed.

Speaker Layout Diagram

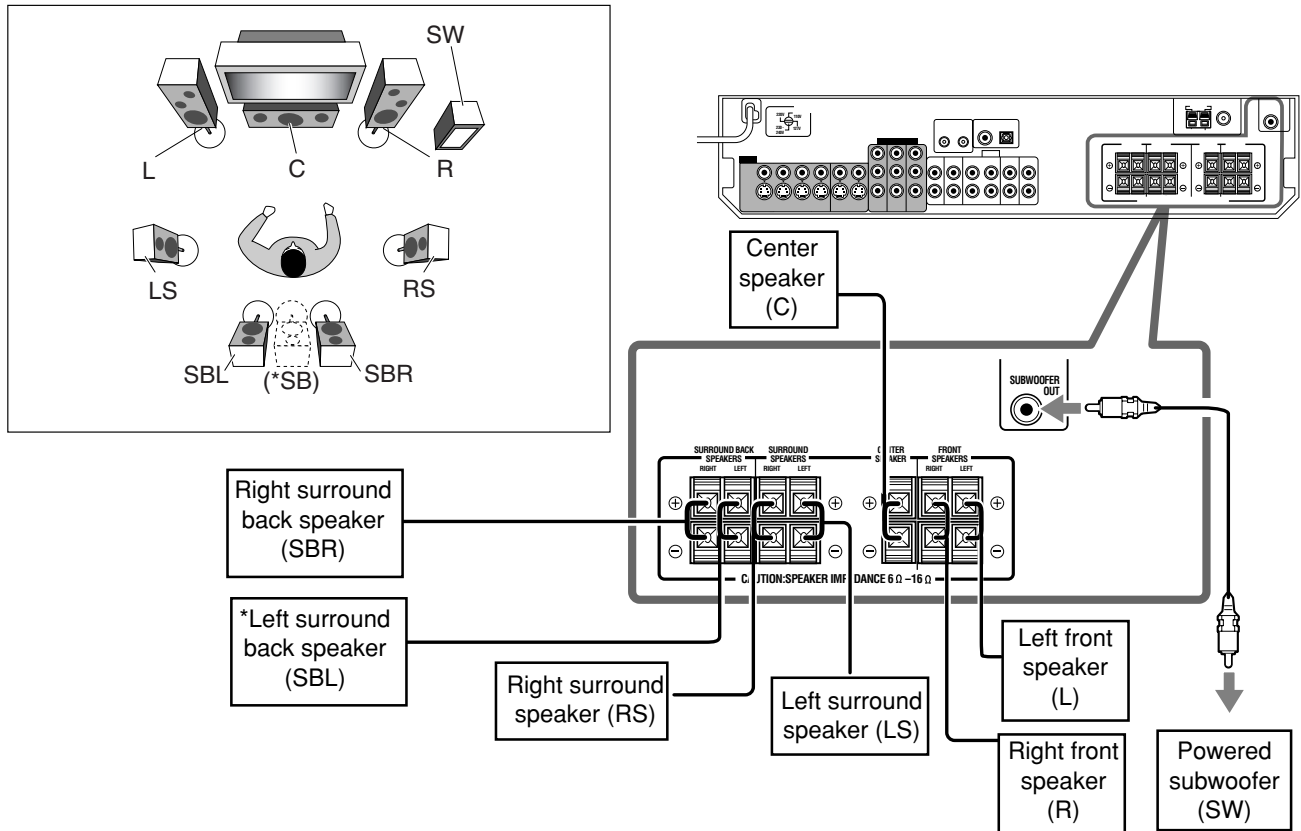

CAUTIONS:

- Use speakers with the SPEAKER IMPEDANCE indicated by the speaker terminals ($6\ \Omega - 16\ \Omega$).
- DO NOT connect more than one speaker to one speaker terminal.

Connecting the speakers

Turn off all components before making connections.

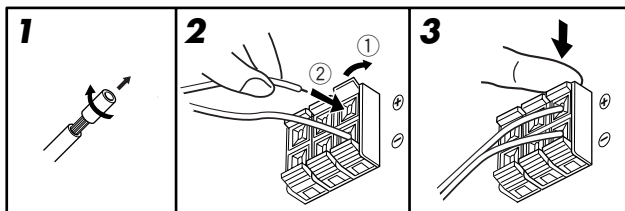

- 1 Twist and remove the insulation at the end of each speaker cord.**
- 2 Open the terminal (1), then insert the speaker cord (2).**
 - For each speaker, connect the (+) and (-) terminals on the rear panel to the (+) and (-) terminals marked on the speakers.
- 3 Close the terminal.**

*When using a single speaker for the surround back speaker

You can enjoy the surround sound by one surround back speaker. When using one surround back speaker,

- set “SB OUT” to “<1SPK>” (see page 17) and
- connect the surround back speaker to the left surround back speaker terminal. **(No sound comes from the speaker if you connect it to the right surround back speaker terminal.)**

Connecting the powered subwoofer

By connecting a subwoofer, you can enhance the bass or reproduce the original LFE signals recorded in digital software.

Connect the input jack of a powered subwoofer to the SUBWOOFER OUT jack on the rear panel, using a cord with RCA pin plugs (not supplied).

- Refer also to the manual supplied with your subwoofer.

After connecting all the speakers and/or a subwoofer, set the speaker setting information properly to obtain the best possible surround effect. For details, see pages 15 to 19.

NOTE

You can place a subwoofer wherever you like since bass sound is non-directional. Normally place it in front of you.

Connecting video components

Do not connect the AC power plug to the wall outlet until all connections are completed.

This receiver is equipped with the following video terminals—composite video, S-video, and component video terminals.

- If your video components have S-video (Y/C-separation) and/or component video (Y, P_B, P_R) jacks, connect them using an S-video cable (not supplied) or component video cable (not supplied). By using these terminals, you can get a better picture quality in the order:

Component > S-video > Composite

IMPORTANT:

The video signals from one type of these input jacks are transmitted only through the video output jacks of the same type. Therefore, if a recording video component and a playing video component are connected to the receiver through the video terminals of different type, you cannot record the picture. In addition, if the TV and a playing video component are connected to the receiver through the video terminals of different type, you cannot view the playback picture on the TV.

Turn off all components before making connections.

- When you connect other components, refer also to their manuals.

DO NOT use a TV through a VCR or a TV with a built-in VCR; otherwise, the picture may be distorted.

CAUTION:

If you connect a sound-enhancing device such as a graphic equalizer between the source components and this receiver, the sound output through this receiver may be distorted.

If your video components have AV COMPU LINK terminal

See also page 32 for detailed information about the connection and the AV COMPU LINK remote control system.

■ Connecting a DVD recorder or DVD player with its stereo output jacks:

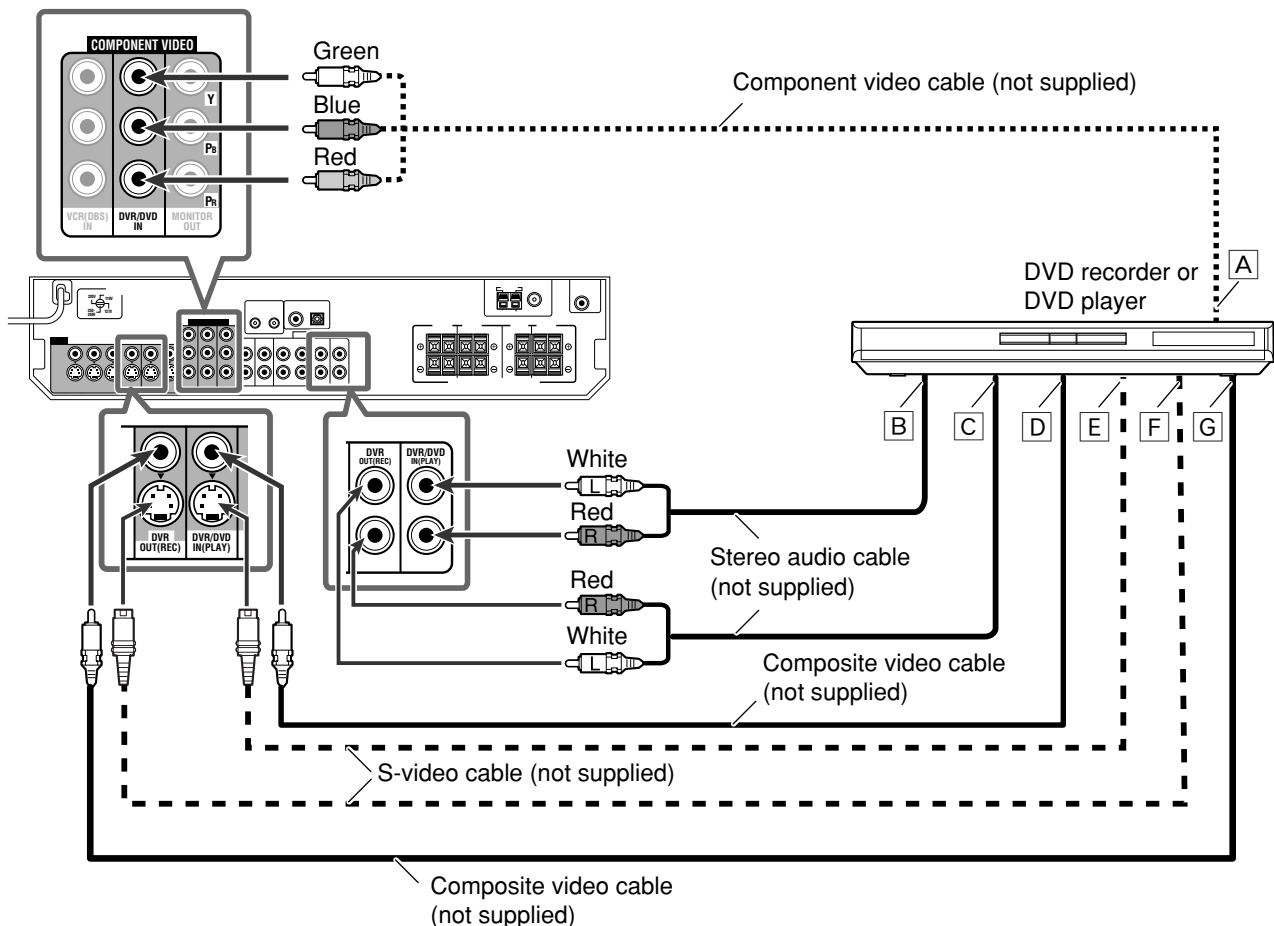

NOTES

- When connecting a DVD recorder or DVD player to the component video input jacks, select the component video input mode (DVD VIDEO IN) correctly. If you do not, you cannot view the playback picture on the TV or the AV COMPU LINK remote control system cannot operate properly. See page 20 for details.
- Select the analog input mode. See "Selecting the analog or digital input mode" on page 12.
- You can enjoy digital sound if using a digital coaxial or optical cable. When shipped from the factory, the audio input mode for a DVD recorder and DVD player is set to use the digital coaxial terminal (DIGITAL IN 1 (DVR/DVD)). For details of digital connection, see page 10.

- A To component video output
 - Connect Y, P_B, and P_R correctly.
- B To left/right audio channel output
- C **Only for DVD recorder:** To left/right audio channel input
- D To composite video output
- E To S-video output
- F **Only for DVD recorder:** To S-video input
- G **Only for DVD recorder:** To composite video input

Do not connect the AC power plug to the wall outlet until all connections are completed.

■ Connecting a VCR

Turn off all components before making connections.

- When you connect other components, refer also to their manuals.

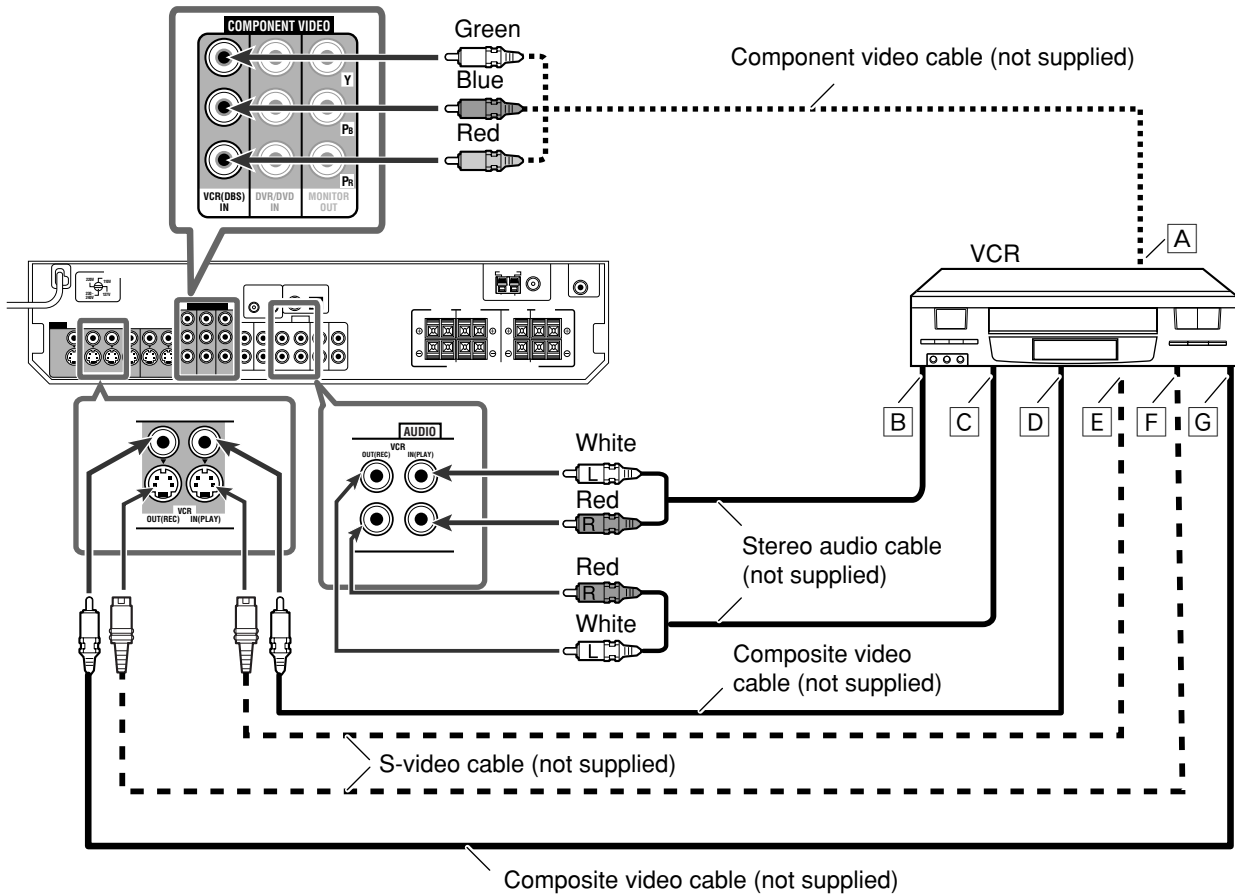

NOTES

- When connecting a VCR to the component video input jacks, select the component video input mode (VCR VIDEO IN) correctly. If you do not, you cannot view the playback picture on the TV or the AV COMPU LINK remote control system cannot operate properly. See page 20 for details.
- Select the analog input mode. See “Selecting the analog or digital input mode” on page 12.
- You can enjoy digital sound if using a digital coaxial or optical cable. For details of digital connection, see page 10.

- A To component video output
 - Connect Y, Pb, and Pr correctly.
- B To left/right audio channel output
- C To left/right audio channel input
- D To composite video output
- E To S-video output
- F To S-video input
- G To composite video input

Do not connect the AC power plug to the wall outlet until all connections are completed.

■ Connecting a DBS tuner

Turn off all components before making connections.

• When you connect other components, refer also to their manuals.

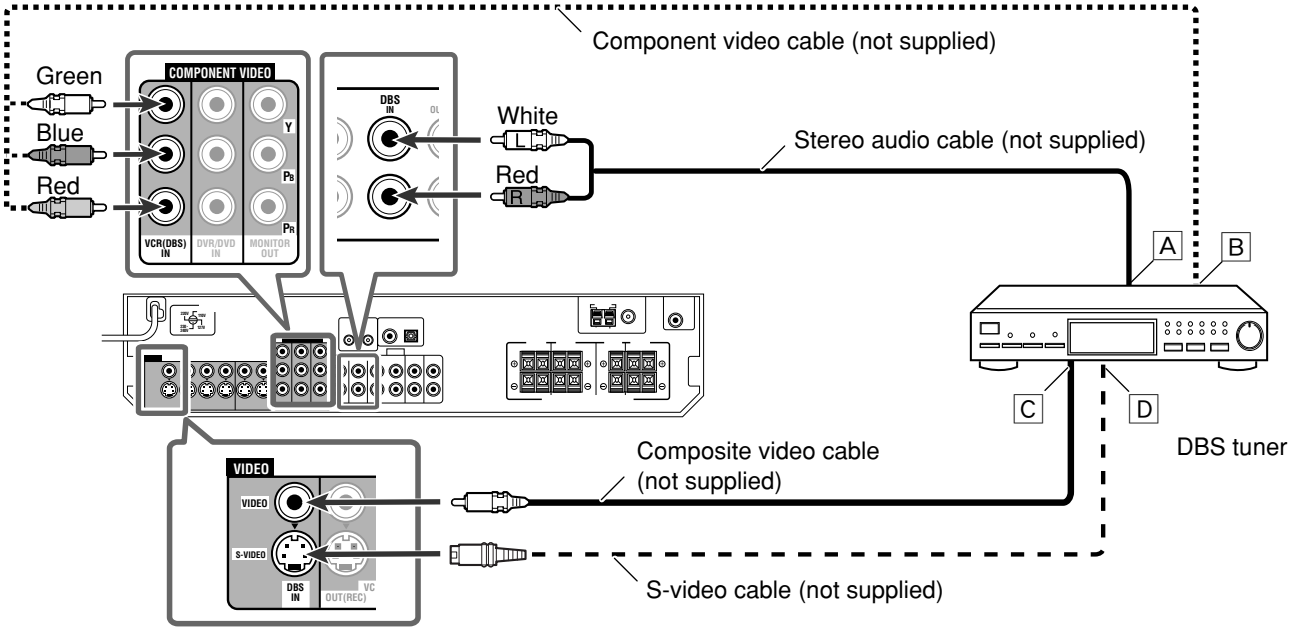

NOTES

- When connecting a DBS tuner to the component video input jacks, select the component video input mode (DBS VIDEO IN) correctly. If you do not, you cannot view the playback picture on the TV. See page 20 for details.
- Select the analog input mode. See "Selecting the analog or digital input mode" on page 12.
- You can enjoy digital sound if using a digital coaxial or optical cable. When shipped from the factory, the audio input mode for a DBS tuner is set to use the digital optical terminal (DIGITAL IN 2 (DBS)). For details of digital connection, see page 10.

- A To left/right audio channel output
- B To component video output
 - Connect Y, Pb, and Pr correctly.
- C To composite video output
- D To S-video output

■ Connecting a TV

Connect the TV to the appropriate MONITOR OUT jacks to view the playback picture from any other connected video components.

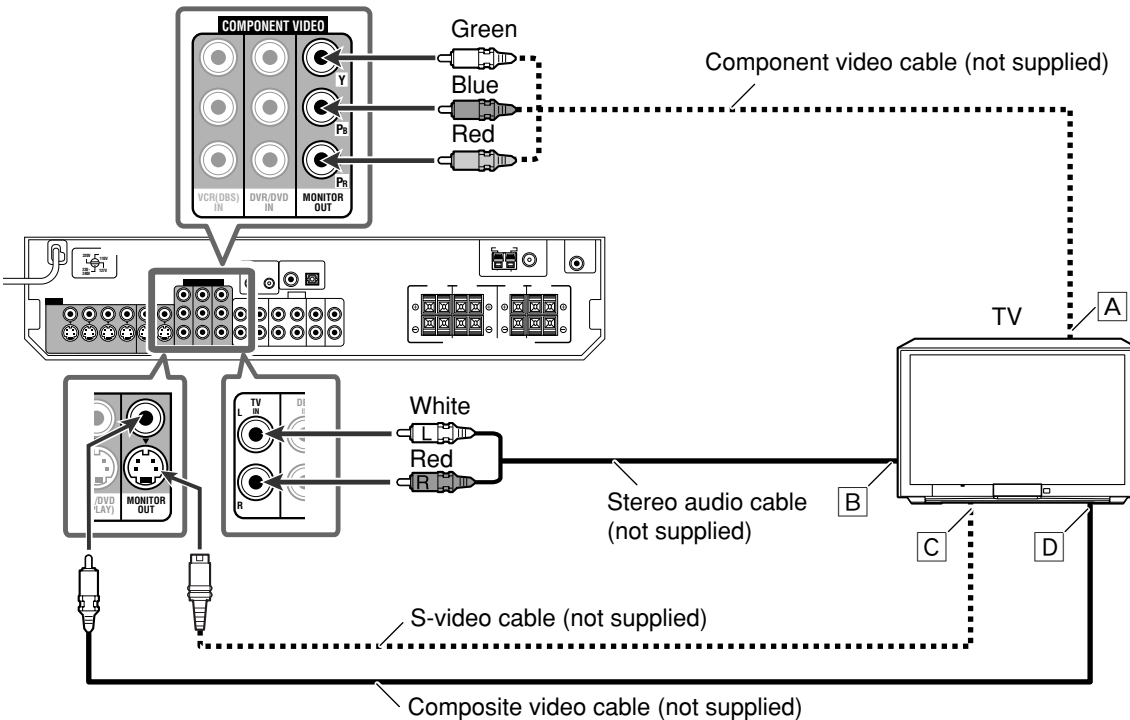

NOTES

- Select the analog input mode. See "Selecting the analog or digital input mode" on page 12.
- You can enjoy digital sound if using a digital coaxial or optical cable. For details of digital connection, see page 10.

- A To component video input
 - Connect Y, Pb, and Pr correctly.
- B To left/right audio channel output
- C To S-video input
- D To composite video input

Digital connection

This receiver is equipped with two DIGITAL IN terminals—one digital coaxial terminal and one digital optical terminal. To reproduce the digital sound, use the digital connection in addition to the analog connection methods described on pages 7 to 9.

Digital coaxial cable (not supplied)



Digital optical cable (not supplied)



Turn off all components before making connections.

- When you connect other components, refer also to their manuals.

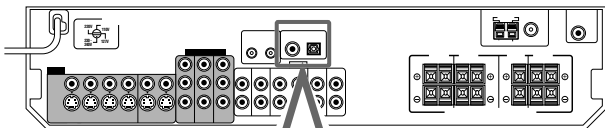

When the component has a digital coaxial output terminal, connect it to the 1(DVR/DVD) terminal, using a digital coaxial cable (not supplied).



When the component has a digital optical output terminal, connect it to the 2(DBS) terminal, using a digital optical cable (not supplied).

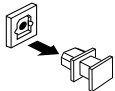

Before connecting a digital optical cable, unplug the protective plug.

NOTES

- When shipped from the factory, the DIGITAL IN terminals have been set for use with the following components:
 - 1(DVR/DVD): For DVD recorder or DVD player
 - 2(DBS): For DBS tuner
 If you connect other components, change the digital input (DIGITAL IN) terminal setting correctly. See "Setting the digital input (DIGITAL IN) terminals—DIGITAL IN 1/2" on page 20.
- Select the correct digital input mode. See "Selecting the analog or digital input mode" on pages 12.
- When you want to operate the connected component (except DBS tuner) using the AV COMPU LINK remote control system (see pages 32 and 33), connect them also as described on pages 7 to 9.

USB Connection

This receiver is equipped with a USB terminal on the front panel. You can connect your PC to this terminal and enjoy sound reproduced through your PC.

When you connect your PC for the first time, follow the procedure below.

- Remember you cannot send any signal or data to your PC from this receiver.

IMPORTANT:

Check if your PC equipped with the CD-ROM drive is running on Windows® 98 SE*, Windows® Me*, Windows® 2000*, or Windows® XP* and prepare its CD-ROM.

How to install the USB drivers

The following procedure is described using the English version of Windows® XP. If your PC is running on a different version of operation system or language, the screens shown on your PC's monitor will differ from the ones used in the following procedure.

1. **Turn on your PC and start running Windows® 98 SE, Windows® Me, Windows® 2000, or Windows® XP.**
 - If the PC has been turned on, quit all the applications now running.
2. **Turn on the receiver, and select the source as "USB DIGITAL."**
3. **Set the volume to minimum.**

IMPORTANT:

Always set volume to "0" when connecting or disconnecting the other equipment.

4. **Connect the unit to the PC using a USB cable (not supplied).**

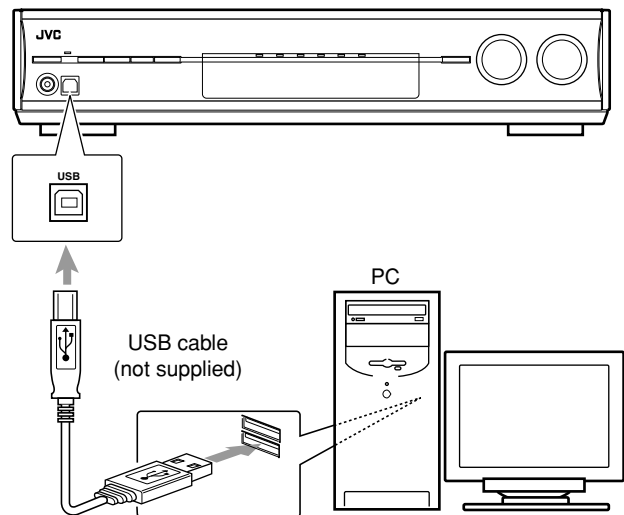

- Use "USB series A plug to B plug" cable when connecting.

5. The USB drivers are installed automatically.

- If the USB drivers are not installed automatically, install the USB drivers by following the instructions on the PC's monitor.

6. Check if the drivers are correctly installed.

1. Open the Control Panel on your PC:
Select [Start] → [Control Panel].
 2. Select [System] → [Hardware] → [Device Manager] → [Sound, video and game controllers] → [Universal Serial Bus controllers].
- The following window appears, and you can check whether the drivers are installed.

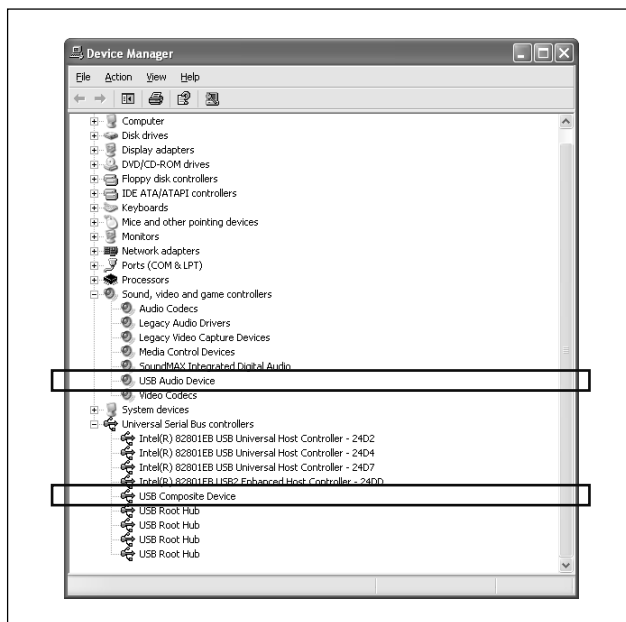

Now PC is ready for playback through the USB connection.

After installation is completed, you can use your PC as the playback source. The PC automatically recognizes the receiver whenever a USB cable is connected between the PC and the receiver while the receiver is turned on.

- When not using the PC as the playback source, disconnect the USB cable.

To play back sounds on the PC, refer to the manuals supplied with the sound reproduction application installed in the PC.

If no sound comes from the speakers, check the following items:

- select the source as “USB DIGITAL”.
- connect the USB cable correctly.
- check the USB device is recognized properly.
- check the playback software in your PC is compatible with the USB device.
- open the Control Panel on your PC, select [Sounds and Audio Devices] → [Audio] tab → [Sound playback] → [Default device], and check [Default device] is set to [USB Audio device].

NOTES

- DO NOT turn off the receiver or disconnect the USB cable while installing the drivers and for several seconds while your PC is recognizing the receiver.
- Use a USB cable (version 1.1 or later). Recommended cord length is 1.5 m.
- If your PC does not recognize the receiver, disconnect the USB cable and connect it again. If it does not work yet, restart Windows.
- The installed drivers can be recognized only when the USB cable is connected between the receiver and your PC.
- The sound may not be played back correctly—interrupted or degraded—due to your PC settings and PC specifications.

* Microsoft®, Windows® 98 SE, Windows® Me, Windows® 2000, and Windows® XP are registered trademarks of Microsoft corporation.

Connecting the power cord

When all the audio/video connections have been made, connect the AC power plug to the wall outlet. Make sure that the plugs are inserted firmly. The standby lamp lights in red.

CAUTIONS:

- Do not plug in before setting the VOLTAGE SELECTOR switch on the rear of the receiver and all connection procedures are complete.
- Do not touch the power cord with wet hands.
- Do not alter, twist or pull the power cord, or put anything heavy on it, which may cause fire, electric shock, or other accidents.
- If the cord is damaged, consult a dealer and have the power cord replaced with a new one.

NOTES

- Keep the power cord away from the connecting cables and the antenna. The power cord may cause noise or screen interference.
- The preset settings such as preset channels and sound adjustment may be erased in a few days in the following cases:
 - When you unplug the power cord.
 - When a power failure occurs.
- If the wall outlet does not match the AC plug, use the supplied AC plug adaptor.
- When you unplug the power cord with the receiver on and connect the power cord again, the receiver enters standby mode.

Basic operations

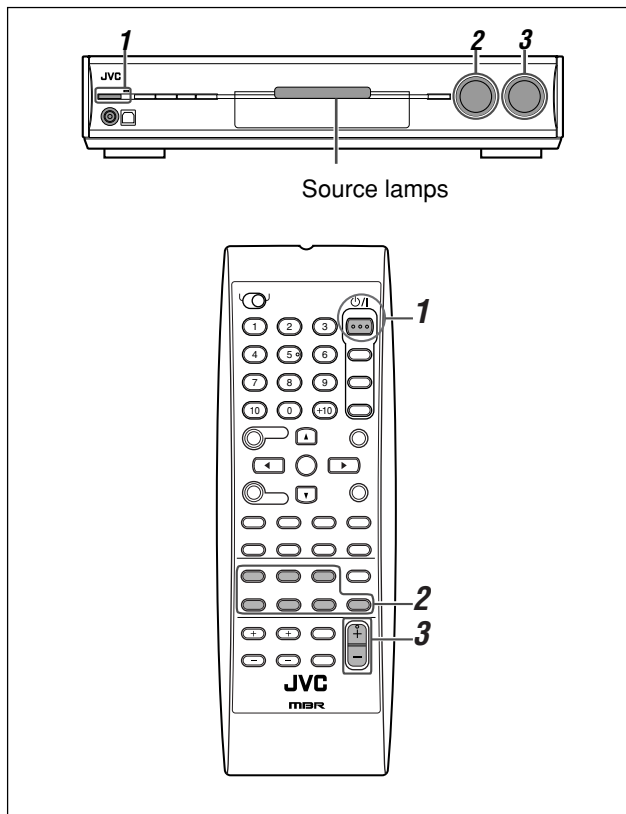

1 Turn on the power

Press **⏻/I STANDBY/ON** (or **STANDBY/ON ⏻/I AUDIO** on the remote control).

The standby lamp goes off and the source lamp of the current source lights in red.

Current source name appears.

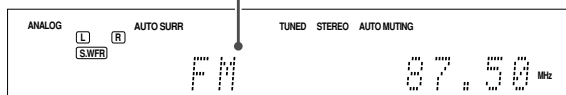

To turn off the power (into standby)

Press **⏻/I STANDBY/ON** (or **STANDBY/ON ⏻/I AUDIO** on the remote control) again.

The standby lamp lights in red.

NOTE

A small amount of power is consumed in standby mode. To turn the power off completely, unplug the AC power cord.

2 Select the source to play

On the front panel:

Turn **SOURCE SELECTOR** until the source name you want appears on the display.

The source lamp corresponding to the selected source lights in red.

- As you turn **SOURCE SELECTOR**, the source changes as follows:

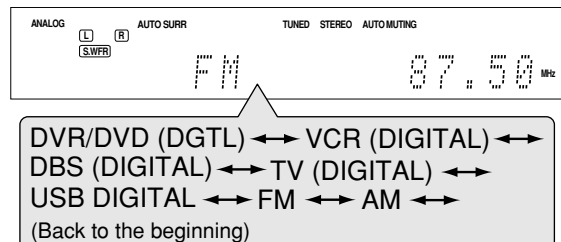

- DVR/DVD (DGTL)*:** Select the DVD recorder or DVD player.
- VCR (DIGITAL)*:** Select the VCR.
- DBS (DIGITAL)*:** Select the DBS tuner.
- TV (DIGITAL)*:** Select the TV.
- USB DIGITAL:** Select the PC component.
- FM:** Select an FM broadcast.
- AM:** Select an AM broadcast.

From the remote control:

Press one of the source selecting buttons.

- For the tuner, press **FM/AM**. Each time you press **FM/AM**, the band alternates between FM and AM.

* Selecting the analog or digital input mode

You need to select the proper input mode according to the connection method (analog or digital) on pages 7 to 10.

- In case of digital connection, you also need to select the correct digital input terminal. (See "Setting the digital input (DIGITAL IN) terminals—DIGITAL IN 1/2" on page 20.)
- "**DGTL AUTO**" and "**ANALOG**" setting are memorized for each source.

From the remote control ONLY:

Press **ANALOG/DIGITAL** to select the analog or digital input mode.

- Each time you press the button, the input mode changes as follows:

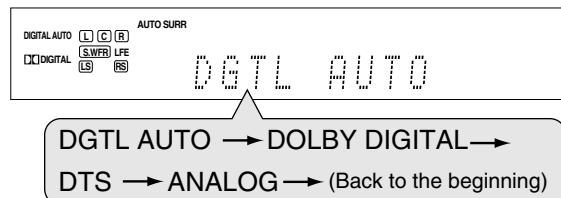

DGTL AUTO (DIGITAL AUTO):

Select for the digital input mode. The receiver automatically detects the incoming signal format, then the digital signal format indicator (LINEAR PCM, DIGITAL, **dts**, or **dts** 96/24) for the detected signal lights up.

DOLBY DIGITAL*: Select to play back software encoded with Dolby Digital.

DTS*: Select to play back software encoded with DTS.

ANALOG: Select for the analog input mode. The ANALOG indicator lights up on the display.

Initial setting: DGTL AUTO

* If the following symptoms occur while playing Dolby Digital or DTS software with "DGTL AUTO" selected, select "DOLBY DIGITAL" or "DTS."

- Sound does not come out at the beginning of playback.
- Noise comes out while searching for or skipping chapters or tracks.

Ex.: When Dolby Digital is selected

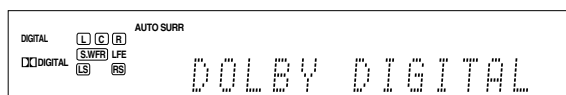
**NOTES**

- You cannot select the digital input mode when selecting "FM" or "AM" as the source.
- The input mode is fixed to "DGTL AUTO" when selecting "USB DIGITAL" as the source.
- When you turn off the power or select another source, "DOLBY DIGITAL" or "DTS" is canceled and the digital mode is automatically reset to "DGTL AUTO."

The following digital signal format indicators on the display indicate what type of signal comes into the receiver.

LINEAR PCM: Lights up when Linear PCM signal comes in.

- DIGITAL:**
- Lights up when Dolby Digital signal comes in.
 - Flashes when "DOLBY DIGITAL" is selected for any software other than Dolby Digital.

- dts:**
- Lights up when conventional DTS signal comes in.
 - Flashes when "DTS" is selected for any software other than DTS.

dts 96/24: Lights up when DTS 96/24 signal comes in.

NOTE

When "DGTL AUTO" cannot recognize the incoming signal, no digital signal format indicator lights up on the display.

3 Adjust the volume

To increase the volume, turn **MASTER VOLUME control clockwise** (or press **VOLUME +** on the remote control).

To decrease the volume, turn **MASTER VOLUME control counterclockwise** (or press **VOLUME -** on the remote control).

- When you adjust the volume, the volume level indication appears on the display for a while.

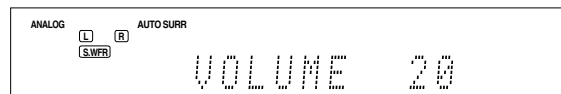
**CAUTION:**

Always set the volume to the minimum before starting any sources. If the volume is set at its high level, the sudden blast of sound energy can permanently damage your hearing and/or ruin your speakers.

NOTE

The volume level can be adjusted within the range of "0" (minimum) to "50" (maximum).

Listening with headphones

You can enjoy not only stereo software but also multi-channel software through the headphones. (Sounds are down-mixed to the front channels while playing multi-channel software.)

Connect a pair of headphones to the PHONES jack on the front panel to activate the HEADPHONE mode.

The HEADPHONE indicator lights up on the display.

- You can also enjoy the Surround/DSP mode through the headphones—3D HEADPHONE mode. For details, see page 28.
- Disconnecting a pair of headphones from the PHONES jack cancels the HEADPHONE (or 3D HEADPHONE) mode and activates the speakers.

CAUTION:

Be sure to turn down the volume:

- Before connecting or putting on headphones, as high volume can damage both the headphones and your hearing.
- Before removing headphones, as high volume may output from the speakers.

Turning off the sounds temporarily

From the remote control ONLY:

Press MUTING to turn off the sound through all connected speakers and headphones.

“MUTING” appears on the display and the volume turns off.

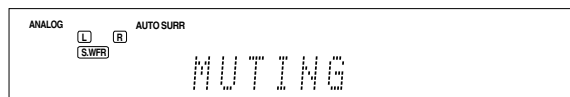

To restore the sound, press MUTING again.

- Pressing VOLUME +/- (or turning MASTER VOLUME control on the front panel) also restores the sound.

Changing the display brightness

You can dim the display—Dimmer.

Press DIMMER repeatedly.

- Each time you press the button, the display brightness changes as follows:

- DIMMER 1: Dims the display.
- DIMMER 2: Dims the display more than DIMMER 1.
- DIMMER 3: Turns off the display.
(Temporarily canceled when you operate the receiver.)
- DIMMER OFF: Cancels the Dimmer (normal display).

Turning off the power with the Sleep Timer

You can fall asleep while listening to music—Sleep Timer.

From the remote control ONLY:

Press SLEEP repeatedly.

- Each time you press the button, the shut-off time changes in 10 minute intervals. The SLEEP indicator lights up on the display.

SLEEP indicator

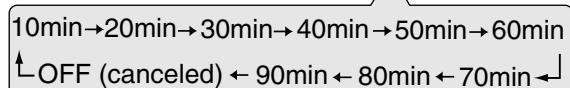
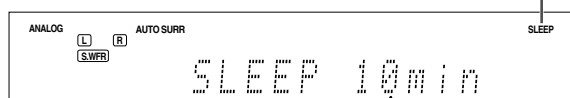

When the shut-off time comes:

The receiver turns off automatically.

To check or change the remaining time until the shut-off time:

Press SLEEP once.

The remaining time (in minutes) until the shut-off time appears.

- To change the shut-off time, press SLEEP repeatedly.

To cancel the Sleep Timer:

Press SLEEP repeatedly so that “SLEEP OFF” appears on the display. (The SLEEP indicator goes off.)

- The Sleep Timer is also canceled when you turn off the receiver.

Basic adjustment of auto memory

This receiver memorizes sound settings for each source:

- when you turn off the power, and
- when you change the source.

When you change the source, the memorized settings for the newly selected source are automatically recalled.

The following can be stored for each source:

- Analog/digital input mode (see page 12)
- Bass boost (see page 23)
- Digital equalization pattern (see page 22)
- Input attenuator mode (see page 23)
- Midnight mode (see page 19)
- Speaker output level (see page 22)
- Surround/DSP mode selection (see page 30)

NOTE

If the source is FM or AM, you can assign a different setting for each band.

Signal and speaker indicators on the display

Signal indicators

Speaker indicators

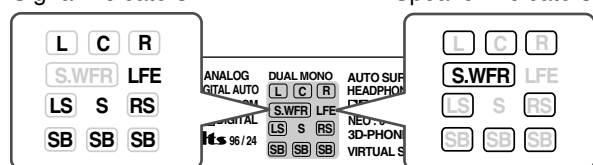

The signal indicators light up as follows:

- L:
 - When digital input is selected: Lights up when the left channel signal comes in.
 - When analog input is selected: Always lights up.
- R:
 - When digital input is selected: Lights up when the right channel signal comes in.
 - When analog input is selected: Always lights up.
- C: Lights up when the center channel signal comes in.
- LS: Lights up when the left surround channel signal comes in.
- RS: Lights up when the right surround channel signal comes in.
- S: Lights up when monaural surround signal comes in.
- SB: Lights up when the surround back channel signal comes in.
- LFE: Lights up when the LFE channel signal comes in.

The speaker indicators light up as follows:

- The subwoofer indicator (S.WFR) lights up when “SUBWOOFER” is set to “SUBWFR <YES>.” For details, see page 17.
- The other speaker indicators light up only when the corresponding speaker is set to “SML (small)” or “LRG (large),” and also when required for the current playback.

Basic settings

To obtain the best possible sound effect from Surround/DSP modes (see pages 27 to 31), you need to set up the speaker and subwoofer information after all the connections are completed. From pages 15 to 20, how to set speakers and other basic items of the receiver are explained.

Setting the speaker information easily—Quick Speaker Setup

Quick Speaker Setup helps you to easily and quickly register the speaker size, speaker distance, and output level of each speaker according to your listening room to create the best possible surround effect.

- You can also register each speaker's information manually. For details, see page 18.

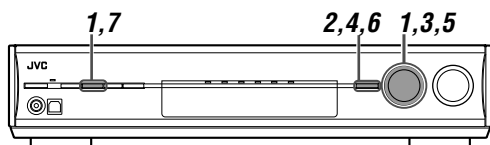

Before you start, remember...

There is a time limit in doing the following steps. If the setting is canceled before you finish, start from step 1 again.

- Press **SETTING** and turn **MULTI JOG** until "**QUICK SPK SET**" appears on the display.

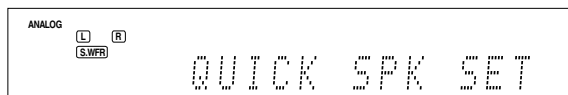

- Press **SET**.

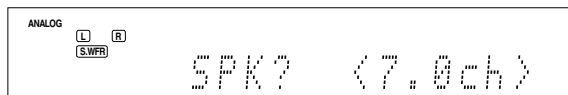

- Turn **MULTI JOG** to select an appropriate number of the connected speakers (speaker channel number).

As you turn the jog, the speaker channel number changes as follows.

- For the details of speaker channel number, see "Speakers (channels) number and the size" on page 16.

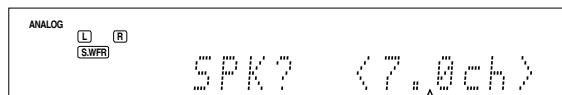

2.0ch ↔ 2.1ch ↔ 3.0ch ↔ 3.1ch ↔
4.0ch ↔ 4.1ch ↔ 5.0ch ↔ 5.1ch ↔
6.0ch ↔ 6.1ch ↔ 7.0ch* ↔ 7.1ch ↔
(Back to the beginning)

* "7.0ch" is the initial setting.

- Press **SET**.

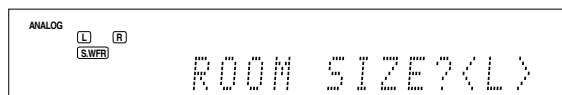

- Turn **MULTI JOG** to select an appropriate room size to match to your listening room.

As you turn the jog, the room size changes as follows.

- To select your appropriate room size, see "Room size and the speaker distance/output level" on page 16.

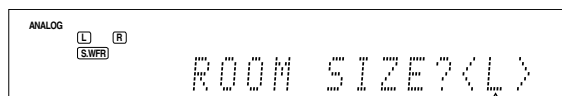

S ↔ M ↔ L* ↔ (Back to the beginning)

* "L" is the initial setting.

- Press **SET**.

QUICK SPEAKER SETUP is now completed, then the display goes back to SETTING menu.

- Press **SETTING**.

NOTES

- This procedure will not be completed if you stop in the middle of the setting process.
- Once Quick Speaker Setup is performed, the speaker output levels are also set to appropriate values automatically (common to all sources). If you want to set the speaker output levels separately for each source, see "Adjusting the speaker output levels" on page 22.

CONTINUED ON THE NEXT PAGE

Speakers (channels) number and the size

You can find how each of the speaker size is defined according to the number of connected speakers (speaker channel "ch" number) you select.

- Subwoofer is counted as 0.1 channel.

CH	The size of connected speakers				
	L/R	C	LS/RS	SB	SUBWFR
2.0CH	LARGE	NONE	NONE	NONE	NO
2.1CH	SMALL	NONE	NONE	NONE	YES
3.0CH	LARGE	SMALL	NONE	NONE	NO
3.1CH	SMALL	SMALL	NONE	NONE	YES
4.0CH	LARGE	NONE	SMALL	NONE	NO
4.1CH	SMALL	NONE	SMALL	NONE	YES
5.0CH	LARGE	SMALL	SMALL	NONE	NO
5.1CH	SMALL	SMALL	SMALL	NONE	YES
6.0CH	LARGE	SMALL	SMALL	SMALL (1SPK)	NO
6.1CH	SMALL	SMALL	SMALL	SMALL (1SPK)	YES
7.0CH	LARGE	SMALL	SMALL	SMALL (2SPK)	NO
7.1CH	SMALL	SMALL	SMALL	SMALL (2SPK)	YES

Room size and the speaker distance/output level

According to the selected room size, speaker distance and speaker output level for each activated speaker is set as follows:

Room size	Speaker	Distance	Output level
L (Large)	L/R	3.0 m (10 ft)	0 dB
	C	3.0 m (10 ft)	0 dB
	LS/RS	3.0 m (10 ft)	0 dB
	SBL(SB)/SBR	3.0 m (10 ft)	0 dB
M (Medium)	L/R	2.7 m (9 ft)	0 dB
	C	2.4 m (8 ft)	-2 dB
	LS/RS	2.1 m (7 ft)	-3 dB
	SBL(SB)/SBR	1.8 m (6 ft)	-4 dB
S (Small)	L/R	2.4 m (8 ft)	0 dB
	C	2.1 m (7 ft)	-2 dB
	LS/RS	1.5 m (5 ft)	-4 dB
	SBL(SB)/SBR	1.2 m (4 ft)	-6 dB

NOTE

Abbreviations used in the tables above stand for the following speakers and the subwoofer:

- L: Left front speaker
- R: Right front speaker
- C: Center speaker
- LS: Left surround speaker
- RS: Right surround speaker
- SB: Surround back speaker
- SBL: Left surround back speaker
- SBR: Right surround back speaker
- SUBWFR: Subwoofer

Basic setting items

You can adjust the following items. See pages in parentheses for details.

- You cannot select the items which is not available with the current setting. For example, when the speaker channel number is set to "<5.1ch>" in Quick Speaker Setup, you cannot select the following items:
S BACK OUT, S BACK DIST, S BACK L DIST, S BACK R DIST

Items	To do
QUICK SPK SET	Register the number of speakers you connect and the size of your listening room. (15)
SUBWOOFER*	Register your subwoofer. (17)
FRONT SPK*	Register your front speaker size. (17)
CENTER SPK*	Register your center speaker size. (17)
SURROUND SPK*	Register your surround speaker size. (17)
S BACK SPK*	Register your surround back speaker size. (17)
S BACK OUT*	Register the number of your surround back speaker(s). (17)
DIST UNIT	Select the measuring unit for the speaker distance. (18)
FRONT L DIST*	Register the distance from the left front speaker to your listening point. (18)
FRONT R DIST*	Register the distance from the right front speaker to your listening point. (18)
CENTER DIST*	Register the distance from the center speaker to your listening point. (18)
SURR L DIST*	Register the distance from the left surround speaker to your listening point. (18)
SURR R DIST*	Register the distance from the right surround speaker to your listening point. (18)
S BACK DIST*	Register the distance from the surround back speaker to your listening point. (18)
S BACK L DIST*	Register the distance from the left surround back speaker to your listening point. (18)
S BACK R DIST*	Register the distance from the right surround back speaker to your listening point. (18)
EX/ES/PLIIX	Select the EX/ES/PLIIX reproduction mode. (18)
DUAL MONO	Select the Dual Mono sound channel. (19)
SUBWOOFER OUT	Select sounds emitted from the subwoofer. (19)
CROSSOVER	Select the cutoff frequency to the subwoofer. (19)
LFE ATT	Attenuate the bass (LFE) sounds. (19)
MIDNIGHT MODE	Reproduce a powerful sound at night. (19)
DIGITAL IN 1	Select the component connected to the digital coaxial terminal—1 (DVR/DVD). (20)
DIGITAL IN 2	Select the component connected to the digital optical terminal—2 (DBS). (20)
DVD VIDEO IN	Select the type of video terminal used for the DVD recorder or DVD player. (20)
VCR VIDEO IN	Select the type of video terminal used for the VCR. (20)
DBS VIDEO IN	Select the type of video terminal used for the DBS tuner. (20)

- * If you have used Quick Speaker Setup on page 15, these settings are not required.

Operating procedure

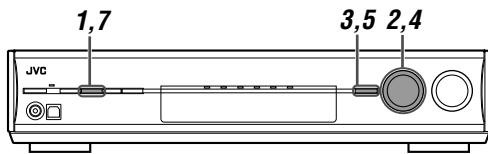

On the front panel ONLY:

Before you start, remember...

There is a time limit in doing the following steps. If the setting is canceled before you finish, start from step **1** again.

Ex.: When setting DIGITAL IN 1 terminal.

1 Press SETTING.

MULTI JOG now works for the setting operation.

2 Turn MULTI JOG until the item you want to set appears on the display.

- As you turn MULTI JOG, the setting items change as follows:

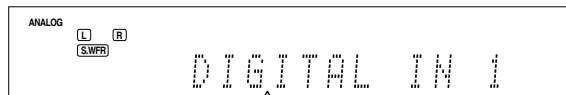

QUICK SPK SET	↔ SUBWOOFER	↔
FRONT SPK	↔ CENTER SPK	↔
SURROUND SPK	↔ S BACK SPK	↔
S BACK OUT	↔ DIST UNIT	↔
FRONT L DIST	↔ FRONT R DIST	↔
CENTER DIST	↔ SURR L DIST	↔
SURR R DIST	↔ S BACK DIST	↔
S BACK L DIST	↔ S BACK R DIST	↔
EX/ES/PLIix	↔ DUAL MONO	↔
SUBWOOFER OUT	↔ CROSSOVER	↔
LFE ATT	↔ MIDNIGHT MODE	↔
DIGITAL IN 1	↔ DIGITAL IN 2	↔
DVD VIDEO IN	↔ VCR VIDEO IN	↔
DBS VIDEO IN	↔ (Back to the beginning)	

3 Press SET.

The current setting of the selected item appears.

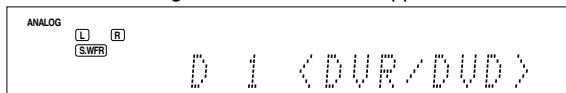

4 Turn MULTI JOG to select the appropriate setting.

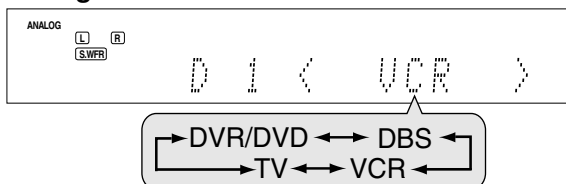

Your setting is stored.

5 Press SET.

6 Repeat steps 2 to 5 to set other items if necessary.

7 Press SETTING.

The source indication resumes on the display.

Setting the speakers

To obtain the best possible surround effect from the Surround and DSP modes, register the setting about the speaker after all connections are completed.

- If you have used Quick Speaker Setup on page 15, this setting is not required.

Setting subwoofer information—SUBWOOFER

Select whether you have connected a subwoofer or not.

SUBWFR <YES>	Select when you have connected a subwoofer. The subwoofer indicator (S.WFR) lights up on the display. You can adjust the subwoofer output level (see page 22).
SUBWFR <NO>	Select when you have disconnected a subwoofer. Selecting this changes the front speaker size to "LRG" (see below).

Initial setting: SUBWFR <NO>

Setting the speaker size—FRONT SPK (front speakers), CENTER SPK (center speaker), SURROUND SPK (surround speakers), S BACK SPK (surround back speakers)

Register the sizes of all the connected speakers.

<LRG> (large)	Select when the cone speaker size is larger than 12 cm.
<SML> (small)	Select when the cone speaker size is smaller than 12 cm.
<NO>	Select when you have disconnected a speaker. (Not selectable for the front speakers.)

Initial setting: <LRG> (for the front speakers)
<SML> (for other speakers)

Setting the surround back speaker(s)—S BACK OUT

Register the number of the surround back speaker(s).

SB OUT <1SPK>	Select when you use 1 surround back speaker.
SB OUT <2SPK>	Select when you use 2 surround back speakers.

Initial setting: SB OUT <2SPK>

NOTES

- If you have selected "SML (small)" for the front speaker size, you cannot select "LRG (large)" for other speakers.
- When "SUBWOOFER" is set to "SUBWFR <NO>," the front speaker size is fixed to "LRG" (and you cannot select "SML").
- When "SURROUND SPK" is set to "SML (small)," you cannot select "LRG (large)" for the surround back speaker.
- When "SURROUND SPK" is set to "NO," the surround back speaker is fixed to "NO."
- When "S BACK SPK" is set to "NO," you cannot select "S BACK OUT."
- When "SB OUT" is set to "<1SPK>," connect the surround back speaker to the left surround back speaker terminal (see page 6). No sound comes from the surround back speaker if you connect it to the right surround back speaker terminal.

Setting the speaker distance

The distance from your listening point to the speakers is one of the important elements to obtain the best possible sound effect from the Surround/DSP modes.

By referring to the speaker distance, the receiver automatically sets the delay time of the sound through each speaker so that sounds through all the speakers can reach you at the same time. If you have used Quick Speaker Setup on page 15, this setting is not required.

■ Measuring unit—DIST UNIT

Select which measuring unit you use.

UNIT <meter> Select to set the distance in meters.

UNIT <feet> Select to set the distance in feet.

Initial setting: UNIT <meter>

■ Speaker distance—

**FRONT L DIST (for the left front speaker),
FRONT R DIST (for the right front speaker),
CENTER DIST (for the center speaker),
SURR L DIST (for the left surround speaker),
SURR R DIST (for the right surround speaker),
S BACK L DIST (for the left surround back speaker),
S BACK R DIST (for the right surround back speaker)**

Adjustable range: 0.3 m to 9.0 m in 0.3 m intervals
(1 ft to 30 ft in 1 ft intervals)

Initial setting: 3.0 m (10 ft) for all speakers

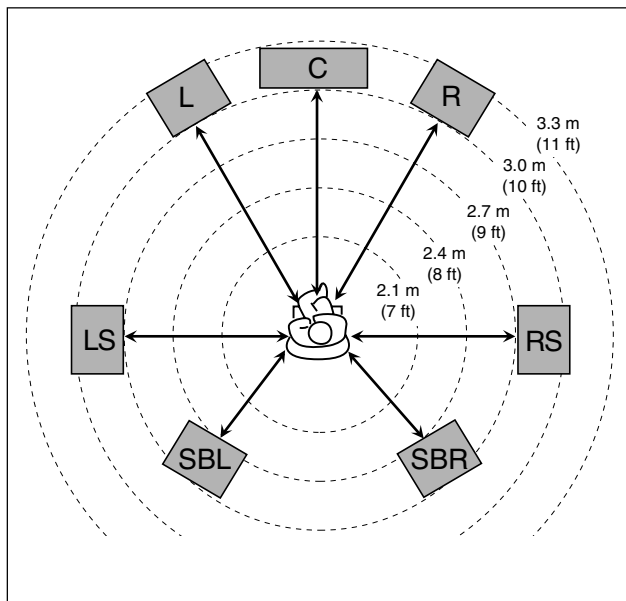

In this case, set the distance as follows:

Left front speaker (L):	"FRONT L <3.0m> (10ft)"
Right front speaker (R):	"FRONT R <3.0m> (10ft)"
Center speaker (C):	"CENTER <3.0m> (10ft)"
Left surround speaker (LS):	"SURR L <2.7m> (9ft)"
Right surround speaker (RS):	"SURR R <2.7m> (9ft)"
Left surround back speaker (SBL):	"SBACK L <2.4m> (8ft)"
Right surround back speaker (SBR):	"SBACK R <2.4m> (8ft)"

NOTES

- You cannot set the speaker distance for the speakers you have set to "NO."
- If you have selected "<1SPK>" for "S BACK OUT" (see page 17), "S BACK DIST" appears instead of "S BACK L DIST" and "S BACK R DIST."

Activating the EX/ES/PLIIX setting—EX/ES/PLIIX

Depending on this setting, available Surround modes for digital multi-channel software vary—EX/ES/PLIIX (7.1-channel) reproduction or 5.1-channel reproduction. Select an appropriate setting for your enjoyment.

- For details about relation between EX/ES/PLIIX setting and available Surround mode, see page 30.
- To activate the Surround mode, see page 31.

<AUTO> According to the incoming signal, an appropriate Surround mode is applied.

- For Dolby Digital Surround EX and DTS-ES software, 6.1-channel reproduction is applied*.
- For other multi-channel (more than 4 channel) encoded software, 5.1-channel reproduction is applied.

<ON> Select to apply 6.1-channel reproduction to both 5.1-channel and 6.1-channel encoded software.

<PLIIX MOVIE> Select to apply PLIIX MOVIE (7.1-channel) reproduction to both 5.1-channel and 6.1-channel encoded software.

<PLIIX MUSIC> Select to apply PLIIX MUSIC (7.1-channel) reproduction to both 5.1-channel and 6.1-channel encoded software.

<OFF> Select to cancel the EX/ES/PLIIX (7.1-channel) reproduction.

Initial setting: <AUTO>

- * For some Dolby Digital Surround EX software, Dolby Digital 5.1-channel reproduction ("DOLBY DIGITAL") may be applied even though you have selected "<AUTO>". In this case, select "<ON>" to apply "DOLBY D EX."

From the remote control:

Press EX/ES/PLIIX repeatedly to select either one of the above.

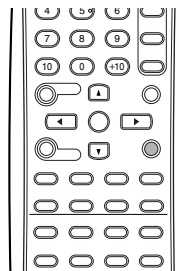

NOTES

- When "SURROUND SPK" is set to "NO" (see page 17), this function is not available.
- When "S BACK SPK" is set to "NO" (see page 17), the Virtual Surround Back (see page 30) is applied for EX/ES/PLIIX (6.1-channel) reproduction.

Selecting the main or sub channel —DUAL MONO

You can select the playback sound (channel) you want while playing digital software recorded (or broadcasted) in Dual Mono mode (see page 28), which includes two monaural channels separately. When the receiver detects Dual Mono signals, the DUAL MONO indicator lights up on the display.

D MONO <MAIN> Select to play back the main channel (Ch 1).* Signal indicator “L” lights up while playing back this channel.

D MONO <SUB> Select to play back the sub-channel (Ch 2).* Signal indicator “R” lights up while playing back this channel.

D MONO <ALL> Select to play back both the main and sub-channels (Ch 1/Ch 2).* Signal indicators “L” and “R” light up while playing back these channels.

Initial setting: D MONO <MAIN>

* Dual Mono signals can be heard from the following speakers—L (left front speaker), R (right front speaker), and C (center speaker), with respect to the current Surround setting:

DUAL MONO setting	SURROUND OFF		With Surround Activated				
			CENTER SPK setting				
			SML/LRG			NO	
L	R	L	C	R	L	R	
MAIN	Ch 1	Ch 1	—	Ch 1	—	Ch 1	Ch 1
SUB	Ch 2	Ch 2	—	Ch 2	—	Ch 2	Ch 2
ALL	Ch 1	Ch 2	—	Ch 1+Ch 2	—	Ch 1+Ch 2	Ch 1+Ch 2

NOTE

The Dual Mono format is not identical with bilingual broadcasting for TV programs. So this setting does not take effect while watching such bilingual programs.

Setting bass sound

Setting subwoofer output—SUBWOOFER OUT

The subwoofer emits the LFE signals* and the bass elements of each speaker set to “SML.”

You can make the bass elements of the front speaker channels (MAIN) emitted through the subwoofer.

SW <LFE> Select to emit the LFE signals and the bass elements of each speaker set to “SML.”

SW <LFE+MAIN> Select to emit the bass elements of the front speakers' channels (MAIN) when no bass elements are emitted through the subwoofer in “SW <LFE>.”

Initial setting: SW <LFE>

NOTE

- When “SUBWOOFER” is set to “SUBWFR <NO>” (see page 17), this function is not available.
- The LFE signals are emitted only when playing the following software with the LFE signals:
 - Dolby Digital multi channel software
 - DTS multi channel software
 When playing analog source or linear PCM software, no LFE signals are emitted.

Setting the crossover frequency—CROSSOVER

Small speakers cannot reproduce the bass sounds efficiently. If you use a small speaker in any position, this receiver automatically reallocates the bass sound elements assigned to the small speaker to the large speakers.

To use this function properly, set this crossover frequency level according to the size of the small speaker connected.

- If you have selected “LRG (large)” for all speakers (see page 17), this function will not take effect (“CROSS OFF” appears).

CROSS <80Hz> Select when the cone speaker unit built in the speaker is about 12 cm.

CROSS <100Hz> Select when the cone speaker unit built in the speaker is about 10 cm.

CROSS <120Hz> Select when the cone speaker unit built in the speaker is about 8 cm.

CROSS <150Hz> Select when the cone speaker unit built in the speaker is about 6 cm.

CROSS <200Hz> Select when the cone speaker unit built in the speaker is less than 5 cm.

Initial setting: CROSS <100Hz>

NOTE

Crossover frequency is not valid for the HEADPHONE and 3D HEADPHONE modes.

Setting the low frequency effect attenuator—LFE ATT

If the bass sound is distorted while playing back software encoded with **Dolby Digital** or **DTS**, set the LFE level to eliminate distortion.

- This function takes effect only when the LFE signals come in.

LFE <0dB> Normally select this.

LFE <-10dB> Select when the bass sound is distorted.

Initial setting: LFE <0dB>

Using the Midnight mode —MIDNIGHT MODE

You can enjoy a powerful sound at night using the Midnight mode. When the Midnight mode is activated, the MIDNIGHT indicator lights up on the display.

MIDNIGHT <OFF> Select when you want to enjoy surround with its full dynamic range. (No effect applied.)

MIDNIGHT <1> Select when you want to reduce the dynamic range a little.

MIDNIGHT <2> Select when you want to apply the compression effect fully (useful at night).

Initial setting: MIDNIGHT <OFF>

From the remote control:

Press **MIDNIGHT** repeatedly to select either one of the above.

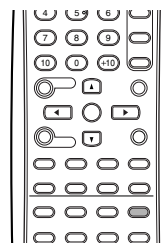

Setting the digital input (DIGITAL IN) terminals—DIGITAL IN 1/2

When you use the digital input terminals, register what components are connected to which terminals—DIGITAL IN 1/2 (see page 10) so that the correct source name will appear when you select the digital source.

Select one of the following components for each terminal:

DVR/DVD	For the DVD player (or DVD recorder).
DBS	For the DBS tuner.
VCR	For the VCR.
TV	For the TV.

Initial setting: DVR/DVD (for "DIGITAL IN 1")
DBS (for "DIGITAL IN 2")

NOTES

- You cannot assign the same component for different terminals. "DIGITAL IN 1" has the priority for assignment to "DIGITAL IN 2."
Ex.: When "DIGITAL IN 1" is set to "DVR/DVD", "DIGITAL IN 2" is selectable for the other components.
- Setting "DIGITAL IN 1" affects "DIGITAL IN 2" settings. When you have changed "DIGITAL IN 1," confirm the components assigned to "DIGITAL IN 2."

Selecting the component video input mode—DVD VIDEO IN/VCR VIDEO IN/DBS VIDEO IN

When you use the component video inputs for connecting the DVD recorder (or DVD player), VCR, or DBS, register the type of video input jacks.

If you have not selected appropriate video input jacks, you cannot view the playback picture on the TV or the AV COMPU LINK remote control system cannot operate properly (see page 32).

For the DVD recorder or DVD player (DVD VIDEO IN):

DVD <S/C>	Select when connecting the DVD recorder (or DVD player) to the composite video or S-video input jacks.
DVD <CMPNT>	Select when connecting the DVD recorder (or DVD player) to the component video input jacks.

Initial setting: DVD <S/C>

For the VCR (VCR VIDEO IN):

VCR <S/C>	Select when connecting the VCR to the composite video or S-video input jacks.
VCR <CMPNT>	Select when connecting the VCR to the component video input jacks.

Initial setting: VCR <S/C>

For the DBS (DBS VIDEO IN):

DBS <S/C>	Select when connecting the DBS to the composite video or S-video input jacks.
DBS <CMPNT>	Select when connecting the DBS to the component video input jacks.

Initial setting: DBS <S/C>

NOTE

You cannot select "CMPNT" for both the VCR and the DBS at the same time. If you select "CMPNT" for the VCR, the setting for the DBS is fixed to "S/C" and vice versa.

Sound adjustments

You can make sound adjustment to your preference after completing basic setting.

Basic adjustment items

You can adjust the following items. See pages in parentheses for details.

- You cannot select the items which is not available with the current setting.

Items	To do
SUBWFR LVL ^{*1}	Adjust the subwoofer output level. (22)
FRONT L LVL ^{*1*2}	Adjust the left front speaker output level. (22)
FRONT R LVL ^{*1*2}	Adjust the right front speaker output level. (22)
CENTER LVL ^{*1*2}	Adjust the center speaker output level. (22)
SURR L LVL ^{*1*2}	Adjust the left surround speaker output level. (22)
SURR R LVL ^{*1*2}	Adjust the right surround speaker output level. (22)
S BACK LVL ^{*1*2}	Adjust the surround back speaker output level. (22)
S BACK L LVL ^{*1*2}	Adjust the left surround back speaker output level. (22)
S BACK R LVL ^{*1*2}	Adjust the right surround back speaker output level. (22)
D EQ 63Hz ^{*1}	Adjust the equalization pattern of each band. (22)
D EQ 250Hz ^{*1}	
D EQ 1kHz ^{*1}	
D EQ 4kHz ^{*1}	
D EQ 16kHz ^{*1}	
BASS BOOST	Boost the bass level. (23)
INPUT ATT	Attenuate the input level of analog source. (23)
EFFECT ^{*1}	Adjust the effect level. (23)
ROOM SIZE	Select the room size for your virtual listening room. (23)
LIVENESS	Select the liveness level for your virtual listening room. (23)
PANORAMA	Add "wraparound" sound effect with side-wall image. (23)
CENTER WIDTH	Adjust the center channel localization between the center speaker and the left/right speakers. (24)
DIMENSION	Adjust sound localization pattern. (24)
CENTER GAIN	Adjust the sound localization of the center channel. (24)
CENTER TONE ^{*1}	Make the center tone soft or sharp. (24)
CENTER ALIGN	Align the vertical localization of the center channel signals. (24)

^{*1} You can also use the remote control for the adjustment.

^{*2} If you have used Quick Speaker Setup on page 15, these settings are not required.

Operating procedure

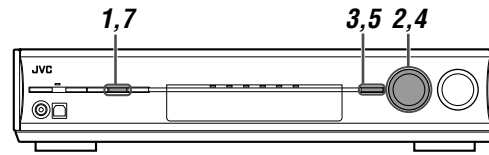

On the front panel:

Before you start, remember...

There is a time limit in doing the following steps. If the setting is canceled before you finish, start from step 1 again.

Ex.: When adjusting subwoofer output level.

1 Press ADJUST.

MULTI JOG now works for the sound adjustment.

2 Turn MULTI JOG until the item you want to adjust appears on the display.

- As you turn MULTI JOG, the adjustment items change as follows:

ANALOG L R
SWFR

SUBWFR LVL

SUBWFR LVL	↔	FRONT L LVL	↔
FRONT R LVL	↔	CENTER LVL	↔
SURR L LVL	↔	SURR R LVL	↔
S BACK LVL	↔	S BACK L LVL	↔
S BACK R LVL	↔	D EQ 63Hz	↔
D EQ 250Hz	↔	D EQ 1kHz	↔
D EQ 4kHz	↔	D EQ 16kHz	↔
BASS BOOST	↔	INPUT ATT	↔
EFFECT	↔	ROOM SIZE	↔
LIVENESS	↔	PANORAMA	↔
CENTER WIDTH	↔	DIMENSION	↔
CENTER GAIN	↔	CENTER TONE	↔
CENTER ALIGN	↔	(Back to the beginning)	

3 Press SET.

The current setting for the selected item appears.

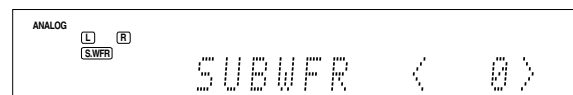

4 Turn MULTI JOG to adjust the selected item.

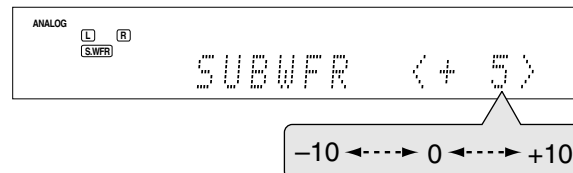

Your adjustment is stored.

5 Press SET.

6 Repeat steps 2 to 5 to adjust other items if necessary.

7 Press ADJUST.

The source indication resumes on the display.

Adjusting the speaker output levels

- SUBWFR LVL (subwoofer output level),
- FRONT L LVL (left front speaker output level),
- FRONT R LVL (right front speaker output level),
- CENTER LVL (center speaker output level),
- SURR L LVL (left surround speaker output level),
- SURR R LVL (right surround speaker output level),
- S BACK L LVL (left surround back speaker output level),
- S BACK R LVL (right surround back speaker output level)

You can adjust the speaker output levels.

Adjust all the speakers' output levels so that you can listen to the sounds from all the speakers at the same level.

- Once you have made an adjustment, it is memorized for each source.

Adjustable range: -10 (dB) to +10 (dB) (in 1 step intervals)

Initial setting: 0 (dB) for all speakers

NOTES

- If you have selected "NO" for a speaker (see page 17), the output level for the corresponding speaker is not adjustable.
- If you have selected "<1SPK>" for "S BACK OUT" (see page 17), "S BACK LVL" appears instead of "S BACK L LVL" and "S BACK R LVL."
- While using the headphones, you can adjust only the left and right front speakers' output level.

From the remote control:

1 Press SOUND.

2 Press TEST to check the speakers' output balance.

"TEST: FRONT L" starts flashing on the display, and a test tone comes out of the speakers clockwise.



- You can adjust the speaker output levels without the test tone.

3 Adjust the speaker output levels.

Press the numeric button corresponding to the speaker you want to adjust, then LEVEL+ or LEVEL- to adjust the output level.

Ex.: To adjust the output level for the left front speaker (L), press FRONT L, then LEVEL+ or LEVEL-.

4 Press TEST again to stop the test tone.

NOTES

- No test tone comes out of the speakers for which the speaker setting is set to "NO" (see page 17).
- No test tone is available when the headphone is in use.
- If you have selected "<1SPK>" for "S BACK OUT" (see page 17), press S BACK L, then LEVEL+ or LEVEL- to adjust the output level.
- After pressing SOUND, the numeric buttons work for sound adjustments. To use the numeric buttons to operate your target source, press the corresponding source selecting button before operation.

Adjusting the equalization patterns— D EQ 63Hz/250Hz/1kHz/4kHz/16kHz

You can adjust equalization patterns in five frequency bands (center frequency: 63 Hz, 250 Hz, 1 kHz, 4 kHz, 16 kHz) for the front speakers.

- Once you have made an adjustment, it is memorized for each source.

Adjustable range: -8 (dB) to +8 (dB) (in 2 dB intervals)

Initial setting: 0 (dB) for all bands

- When adjustment is made, the DIGITAL EQ indicator lights up on the display.

If no adjustment is required, set all the frequency bands to "0 (dB)."

- The DIGITAL EQ indicator goes off from the display.

From the remote control:

Before you start, remember...

There is a time limit in doing the following steps. If the setting is canceled before you finish, start from step 2 again.

1 Press SOUND.

2 Press D. EQ FREQ repeatedly to select the band you want to adjust.

3 Press LEVEL+ or LEVEL- to adjust the equalization pattern of the selected band.

4 Repeat steps 2 and 3 to adjust other bands.

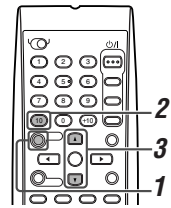

NOTE

After pressing SOUND, the numeric buttons work for sound adjustments. To use the numeric buttons to operate your target source, press the corresponding source selecting button before operation.

Adjusting the bass sounds

Reinforcing the bass—BASS BOOST

You can boost the bass level—Bass Boost.

- Once you have made an adjustment, it is memorized for each source.
- You cannot use the remote control for this setting.

B BOOST <ON> Select to boost the bass level.
The B.BOOST indicator lights up on the display.

B BOOST <OFF> Select to deactivate the Bass Boost.

Initial setting: B BOOST <OFF>

NOTE

This function affects only the sound coming out through the front speakers.

Attenuating the input signal—INPUT ATT

When the input level of **analog source** is too high, the sound will be distorted. If this happens, you need to attenuate the input signal level to prevent the sound distortion.

- Once you have made an adjustment, it is memorized for each source.
- You cannot use the remote control for this setting.

ATT <ON> Select to attenuate the input signal level.
The INPUT ATT indicator lights up on the display.

ATT <NORMAL> Select to deactivate attenuation.

Initial setting: ATT <NORMAL>

Adjusting the sound parameters for the Surround/DSP modes

You can adjust the Surround/DSP sound parameters to your preference.

- For details about the Surround/DSP modes, see pages 27 to 31.

Adjusting the effect level for DSP modes—EFFECT

This setting is available only when one of the DSP modes (except ALL CH STEREO) is in use. To activate DSP mode, see page 31.

- Once you have made an adjustment, it is memorized for each DSP mode.

Adjustable range: 1 to 5 (in 1 step intervals)

Initial setting: EFFECT <3>

As the number increases, the effect becomes stronger.
Normally, select “3.”

From the remote control:

Press **SOUND**, then **EFFECT** repeatedly to select the level you want to adjust.

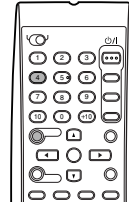

NOTE

After pressing **SOUND**, the numeric buttons work for sound adjustments. To use the numeric buttons to operate your target source, press the corresponding source selecting button before operation.

Adjusting the virtual room size for DSP modes—ROOM SIZE

This setting is available only when one of the DSP modes (except ALL CH STEREO) is in use. To activate DSP mode, see page 31.

- If “SURROUND SPK” is set to “<NO>” (see page 17), this item is not adjustable.
- Once you have made an adjustment, it is memorized for each DSP mode.
- You cannot use the remote control for this setting.

Adjustable range: 1 to 5 (in 1 step intervals)

Initial setting: ROOM SIZE <3>

As the number increases, the interval between reflections increases so that you will feel as if you were in a larger room.
Normally, select “3.”

Adjusting the liveness effect for DSP modes—LIVENESS

This setting is available only when one of the DSP modes (except ALL CH STEREO) is in use. To activate DSP mode, see page 31.

- If “SURROUND SPK” is set to “<NO>” (see page 17), this item is not adjustable.
- Once you have made an adjustment, it is memorized for each DSP mode.
- You cannot use the remote control for this setting.

Adjustable range: 1 to 5 (in 1 step intervals)

Initial setting: LIVENESS <3>

As the number increases, the attenuation level of reflections over time decreases so that acoustics change from “Dead” to “Live.”
Normally, select “3.”

Adjusting the panorama control for Pro Logic IIx Music and Pro Logic II Music—PANORAMA

This setting is available when Pro Logic IIx Music or Pro Logic II Music is activated for the analog or digital 2-channel sound signal. To activate Pro Logic IIx Music or Pro Logic II Music, see page 31.

- Once you have made an adjustment, it is memorized until you change the setting.
- You cannot use the remote control for this setting.

PANORAMA <ON> Select to add “wraparound” sound effect with side-wall image.

PANORAMA <OFF> Select to listen to originally recorded sound.

Initial setting: PANORAMA <OFF>

Adjusting the center channel localization for Pro Logic IIx Music and Pro Logic II Music—CENTER WIDTH

This setting is available when Pro Logic IIx Music or Pro Logic II Music is activated for the analog or digital 2-channel sound signal. To activate Pro Logic IIx Music or Pro Logic II Music, see page 31.

- If “CENTER SPK” is set to “NO” (see page 17), this item is not adjustable.
- Once you have made an adjustment, it is memorized until you change the setting.
- You cannot use the remote control for this setting.

Adjustable range: OFF and 1 to 7 (in 1 step intervals)

Initial setting: C WIDTH <3>

As the number increases, the center channel sound moves toward the left and right speakers.

Normally, select “3.”

Adjusting the sound localization position for Pro Logic IIx Music and Pro Logic II Music—DIMENSION

This setting is available when Pro Logic IIx Music or Pro Logic II Music is activated for the analog or digital 2-channel sound signal. To activate Pro Logic IIx Music or Pro Logic II Music, see page 31.

- Once you have made an adjustment, it is memorized until you change the setting.
- You cannot use the remote control for this setting.

Adjustable range: 1 to 7 (in 1 step intervals)

Initial setting: DIMENSION <4>

As the number increases, the sound localization moves towards forward from backward.

Normally, select “4.”

Adjusting the sound localization of the center channel—CENTER GAIN

This setting is available only when Neo:6 Music is in use.

- If “CENTER SPK” is set to “NO” (see page 17), this item is not adjustable.
- Once you have made an adjustment, it is memorized until you change the setting.
- You cannot use the remote control for this setting.

Adjustable range: 0 to 1.0 (in 0.1 step intervals)

Initial setting: C GAIN <0.3>

As the number increases, the center channel will be localized clearly.

Normally, select “0.3.”

Adjusting the center tone—CENTER TONE

This setting is available when one of the Surround/DSP modes is in use. To activate Surround/DSP mode, see page 31.

- If “CENTER SPK” is set to “NO” (see page 17), this item is not adjustable.
- This setting is common to all Surround modes, and is memorized separately for DSP modes.

Adjustable range: 1 to 5 (in 1 step intervals)

Initial setting: C TONE <3>

As the number increases, the dialogue becomes stronger. Normally, select “3.”

- When the center tone is set to other than “C TONE <3>,” the C.TONE indicator lights up on the display.

From the remote control:

Press **SOUND**, then **C. TONE** repeatedly to select the level you want to adjust.

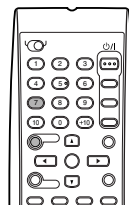

NOTE

After pressing **SOUND**, the numeric buttons work for sound adjustments. To use the numeric buttons to operate your target source, press the corresponding source selecting button before operation.

Aligning the vertical localization of the center channel for Surround/DSP modes—CENTER ALIGN

This setting is available when one of the Surround/DSP modes (except PLIIx MUSIC, PLII MUSIC, NEO:6 MUSIC, and ALL CH STEREO) is in use. To activate Surround/DSP mode, see page 31.

- If “CENTER SPK” is set to “NO” (see page 17), this item is not adjustable.
- Once you have made an adjustment, it is memorized for each Surround/DSP mode.
- You cannot use the remote control for this setting.

C ALIGN <ON> Select this when you cannot feel as if the actors or singers are speaking or singing on the screen.

C ALIGN <OFF> Center alignment is turned off.

Initial setting: C ALIGN <OFF>

Tuner operations

Tuner operations are mainly done from the remote control.

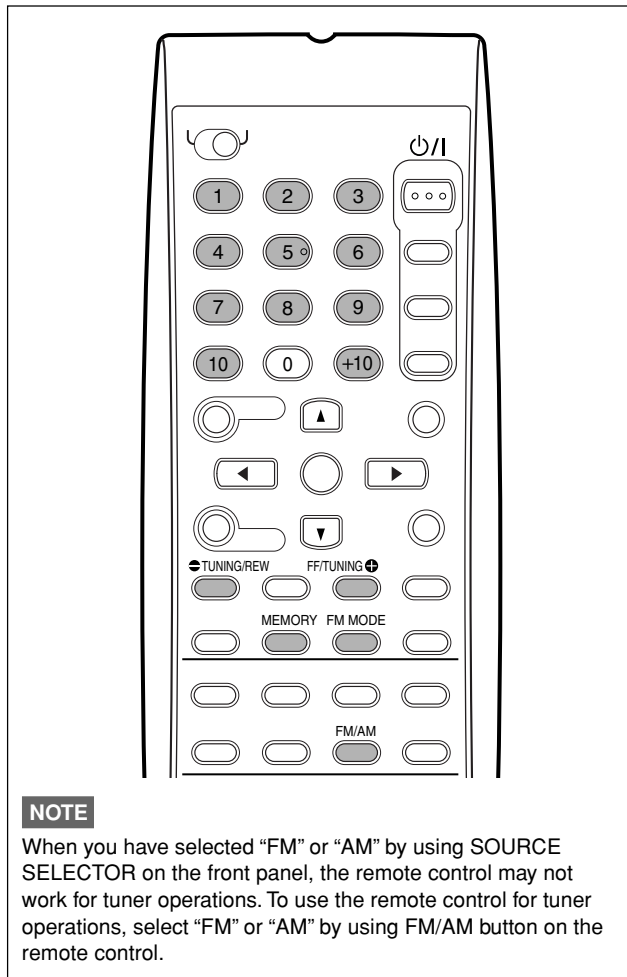

Setting the AM tuner interval spacing

Some countries space AM stations 9 kHz apart, and other countries use 10 kHz spacing. 9 kHz interval spacing is the initial setting.

- Be sure the receiver is turned off, but is plugged into an AC outlet when setting the AM tuner interval.

On the front panel ONLY:

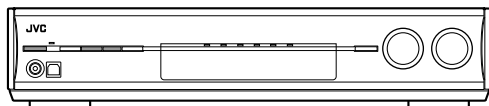

To select the 10 kHz interval:

Hold down ADJUST and press ϕ /I STANDBY/ON. "10k STEP" appears on the display.

To change back to the 9 kHz interval:

Hold down SETTING and press ϕ /I STANDBY/ON. "9k STEP" appears on the display.

NOTE

When you change the AM tuner interval spacing, stored preset stations are erased. In this case, restore stations.

Tuning in to stations manually

From the remote control ONLY:

1 Press FM/AM to select the band.

The last received station of the selected band is tuned in.

- Each time you press the button, the band alternates between FM and AM.

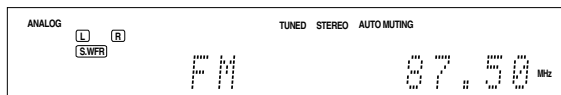

2 Press repeatedly or hold TUNING + or TUNING - until the station you want is tuned in.

- Pressing (or holding) TUNING + increases the frequency.
- Pressing (or holding) TUNING - decreases the frequency.

NOTES

- When you hold and release TUNING + or TUNING -, the frequency keeps changing until a station is tuned in.
- When a station of sufficient signal strength is tuned in, the TUNED indicator lights up on the display.
- When an FM stereo program is received, the STEREO indicator also lights up.

Using preset tuning

Once a station is assigned a channel number, the station can be quickly tuned simply by selecting the number. You can preset up to 30 FM and 15 AM stations.

To store the preset stations

Before you start, remember...

There is a time limit in doing the following steps. If the setting is canceled before you finish, start from step 2 again.

From the remote control ONLY:

1 Tune in to the station you want to preset (see "Tuning in to stations manually" above).

- If you want to store the FM reception mode for this station, select the FM reception mode you want. See "Selecting the FM reception mode" on page 26.

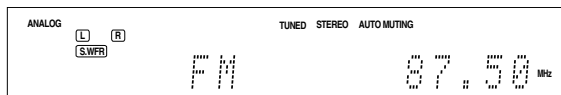

2 Press MEMORY.

The channel number position starts flashing on the display for about 5 seconds.

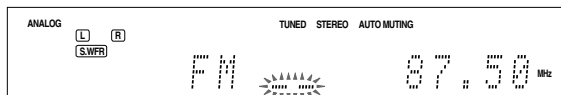

CONTINUED ON THE NEXT PAGE

3 Press the numeric buttons (1 – 10, +10) to select a channel number while the channel number position is flashing.

- For channel number 5, press 5.
- For channel number 15, press +10, then 5.
- For channel number 30, press +10, +10, then 10.

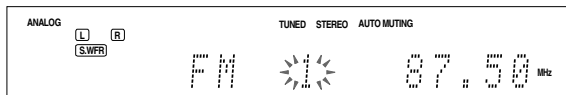

4 Press MEMORY again while the selected channel number is flashing on the display.

The selected channel number stops flashing.
The station is assigned to the selected channel number.

5 Repeat steps 1 to 4 until you store all the stations you want.

To erase a stored preset station

Storing a new station on a used channel number erases the previously stored one.

To tune in a preset station

From the remote control:

1 Press FM/AM to select the band.

The last received station of the selected band is tuned in and the numeric buttons now work for tuner operations.

- Each time you press the button, the band alternates between FM and AM.

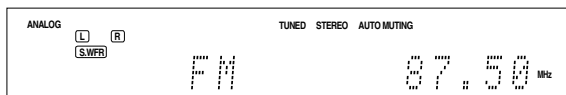

2 Press the numeric buttons (1 – 10, +10) to select a preset channel number.

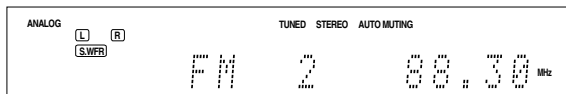

- For channel number 5, press 5.
- For channel number 15, press +10, then 5.
- For channel number 30, press +10, +10, then 10.

On the front panel:

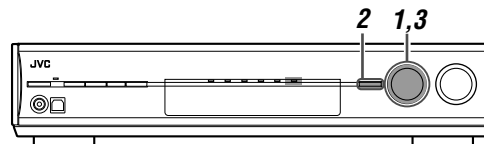

Before you start, remember...

There is a time limit in doing the following steps. If the setting is canceled before you finish, start from step 2 again.

1 Turn SOURCE SELECTOR to select "FM" or "AM."

The last received station of the selected band is tuned in.

2 Press TUNER PRESET.

"P" appears on the display, and MULTI JOG now works for selecting preset channels.

3 Turn MULTI JOG to select a preset channel number.

- To increase the preset channel numbers, turn MULTI JOG clockwise.
- To decrease the preset channel numbers, turn MULTI JOG counterclockwise.

Selecting the FM reception mode

When an FM stereo broadcast is hard to receive or noisy, you can change the FM reception mode while receiving an FM broadcast.

- You can store the FM reception mode for each preset station (see page 25).

From the remote control ONLY:

While listening to an FM station, press FM MODE.

- Each time you press the button, the FM reception mode alternates between "AUTO MUTING" and "MONO."

AUTO MUTING

Normally select this.

When a program is broadcast in stereo, you will hear stereo sound; when in monaural, you will hear monaural sound. This mode is also useful to suppress static noise between stations. The AUTO MUTING indicator lights up on the display.

MONO

Select this to improve the reception (but stereo effect will be lost). In this mode, you will hear noise while tuning in to the stations. The AUTO MUTING indicator goes off from the display. (The STEREO indicator also goes off.)

Initial setting: AUTO MUTING

Creating realistic sound fields

Reproducing theater ambience

In a movie theater, many speakers are located on the walls to reproduce impressive multi-channel sound, reaching you from all directions.

With these many speakers, sound localization and sound movement can be expressed.

Surround/DSP modes built in this receiver can create almost the same Surround sound as you can feel in a real movie theater.

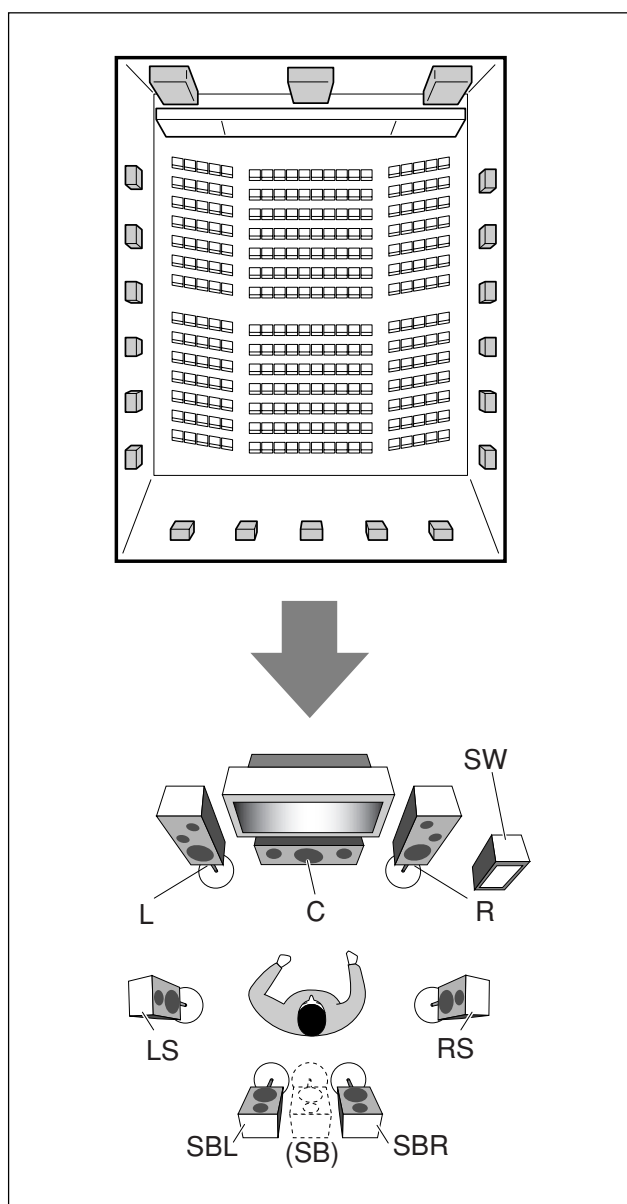

Introducing the Surround modes

■ Dolby Digital*

Dolby Digital is a digital signal compression method, developed by Dolby Laboratories, and enables multi-channel encoding and decoding.

- When Dolby Digital signal is detected through the digital input, the DIGITAL indicator lights up on the display.

Dolby Digital 5.1CH

Dolby Digital 5.1CH (DOLBY DIGITAL) encoding method records and digitally compresses the left front channel, right front channel, center channel, left surround channel, right surround channel, and LFE channel signals (total 6 channels, but the LFE channel is counted as 0.1 channel. Therefore, called 5.1 channel).

Dolby Digital enables stereo surround sounds, and sets the cutoff frequency of the surround treble at 20 kHz, compared to 7 kHz for Dolby Pro Logic. As such, the sound movement and “being-there” feeling are enhanced much more than Dolby Pro Logic.

Dolby Digital EX

Dolby Digital EX (DOLBY D EX) is a digital surround encoding format that adds the third surround channels, called “surround back.”

Compared to the conventional Dolby Digital 5.1CH, these newly added surround back channels can reproduce more detailed movements behind you while viewing the video software. In addition, surround sound localization will become more stable.

■ Dolby Surround

Dolby Pro Logic II

Dolby Pro Logic II is a multi-channel playback format to convert 2-channel software into 5-channel (plus subwoofer). The matrix-based conversion method used for Dolby Pro Logic II makes no limitation for the cutoff frequency of the surround treble and enables stereo surround sound.

- This receiver provides two types of Dolby Pro Logic II modes—**Pro Logic II Movie** (PLII MOVIE) and **Pro Logic II Music** (PLII MUSIC).

When Dolby Pro Logic II is activated, the PLII indicator lights up on the display.

PLII MOVIE Suitable for playing any Dolby Surround encoded software. You can enjoy a sound field very close to the one created with discrete 5.1-channel sounds.

PLII MUSIC Suitable for playing any 2-channel stereo software. You can enjoy wide and deep sounds.

* Manufactured under license from Dolby Laboratories. “Dolby”, “Pro Logic”, and the double-D symbol are trademarks of Dolby Laboratories.

CONTINUED ON THE NEXT PAGE

Dolby Pro Logic IIx

Dolby Pro Logic IIx is a newly introduced multi-channel playback format to convert not only multi-channel software but 2-channel software into 7.1 channel (or 6.1 channel) that developed from Dolby Pro Logic II. The matrix-based conversion method used for Dolby Pro Logic IIx makes no limitation for the cutoff frequency of the surround treble.

- This receiver provides two types of Dolby Pro Logic IIx modes—**Pro Logic IIx Movie** (PLIIx MOVIE) and **Pro Logic IIx Music** (PLIIx MUSIC).

When Dolby Pro Logic IIx is activated, "PLIIx MOVIE" or "PLIIx MUSIC" appear and the  indicator lights up on the display.

PLIIx MOVIE Suitable for playing any Dolby Surround encoded software. You can enjoy a sound field with a natural wraparound effect.

PLIIx MUSIC Suitable for playing any 2-channel stereo software. You can enjoy wide and deep 7.1-channel sounds.

- To enjoy software encoded with Dolby Digital, connect the source component using the digital terminal on the rear of this receiver. (See page 10.)

■ DTS**

DTS is another digital signal compression method, developed by Digital Theater Systems, Inc., and enables multi-channel encoding and decoding (1ch up to 6.1ch).

- When DTS signal is detected through the digital input, the  indicator lights up on the display.

DTS Digital Surround

DTS Digital Surround (DTS) is another discrete 5.1 channel digital audio format available on CD, LD, and DVD software. Compared to Dolby Digital, the DTS Digital Surround format has a lower audio compression rate which enables it to add breadth and depth to the sounds reproduced. As such, DTS Digital Surround features natural, solid, and clear sound.

DTS Extended Surround (DTS-ES)

DTS-ES is another multi-channel digital encoding format.

It greatly improves the 360-degree surround impression and space expression by adding the third surround channel—surround back channel.

DTS-ES includes two signal formats with different surround signal recording methods—**DTS-ES Discrete 6.1ch** (ES DISCRETE) and **DTS-ES Matrix 6.1ch** (ES MATRIX).

DTS-ES Discrete 6.1ch has been designed to encode (and decode) a 6.1-channel signal discretely to avoid interference with each channel.

DTS-ES Matrix 6.1ch has been designed to add an extra surround channel to DTS Digital Surround 5.1-channel. By using a matrix encoding/decoding method, an additional "surround back" channel signal is encoded (and decoded) in both the left and right surround channel signals.

DTS 96/24

In recent years, there has been increasing interest in higher sampling rates both for recording and for reproducing at home. Higher sampling rates allow wider frequency range and greater bit depths provide extended dynamic range.

DTS 96/24 is a multi-channel digital signal format (fs 96 kHz/24 bits) introduced by Digital Theater Systems, Inc. to deliver "better-than-CD sound quality" into the home.

- When DTS 96/24 signal is detected, the  and 96/24 indicators light up. You can enjoy its 5.1-channel sound with full-quality.

DTS Neo:6

DTS Neo:6 is another conversion method to create 6-channel (plus subwoofer) from analog/digital 2-channel software by using the high precision digital matrix decoder used for DTS-ES Matrix 6.1ch.

- This receiver provides the following DTS Neo:6 modes—**Neo:6 Cinema** (NEO:6 CINEMA) and **Neo:6 Music** (NEO:6 MUSIC). When one of them is activated, the NEO:6 indicator lights up on the display.

NEO:6 CINEMA Suitable for playing movies. You can get the same atmosphere with 2-channel software as with 6.1-channel software. It is also effective for playing software encoded with conventional surround formats.

NEO:6 MUSIC Suitable for playing music software. The front channel signals bypass the decoder (resulting in no loss of sound quality) and the surround signals transmitted through the other speakers expand the sound field naturally.

** "DTS", "DTS-ES", "Neo:6" and "DTS 96/24" are trademarks of Digital Theater Systems, Inc.

When using Surround mode, the sounds come out of the activated speakers which the Surround mode requires.

- If either "**SURROUND SPK**" or "**CENTER SPK**" is set to "**<NO>**" in the speaker setting (see page 17), the corresponding channel signals are allocated to and emitted through the front speakers.
- If both "**SURROUND SPK**" and "**CENTER SPK**" are set to "**<NO>**" in the speaker setting (see page 17), JVC's original 3D-PHONIC processing (which has been developed to create the surround effect through the front speakers only) is used. The 3D-PHONIC indicator lights up on the display.

3D HEADPHONE mode

If you connect a pair of headphones while one of the Surround modes is in use, the 3D HEADPHONE mode is activated without respect to the type of software played back. "3D HEADPHONE" appears on the display and the DSP and HEADPHONE indicators light up.

About other digital signals

Linear PCM

Uncompressed digital audio data used for DVDs, CDs, and Video CDs.

DVDs support 2 channels with sampling rates of 48/96 kHz, at quantization of 16/20/24 bits. On the other hand, CDs and Video CDs are limited to 2 channels with 44.1 kHz at 16 bits.

- When Linear PCM signal is detected, the LINEAR PCM indicator lights up.

Dual Mono

Dual Mono can be easily understood when you think of the bilingual broadcast for TV programs (however, the Dual Mono format is not identical with those analog formats).

This format is now adopted in Dolby Digital, DTS, and so on. It allows two independent channels (called main channel and sub-channel) to be recorded separately.

- You can select either channel you want to listen to (see page 19).

Introducing the DSP modes

The sound heard in a concert hall, club, etc. consists of direct sound and indirect sound—early reflections and reflections from behind.

Direct sounds reach the listener directly without any reflection. On the other hand, indirect sounds are delayed by the distances of the ceiling and walls. These direct sounds and indirect sounds are the most important elements of the acoustic surround effects.

The DSP modes can create these important elements, and give you a real “being there” feeling.

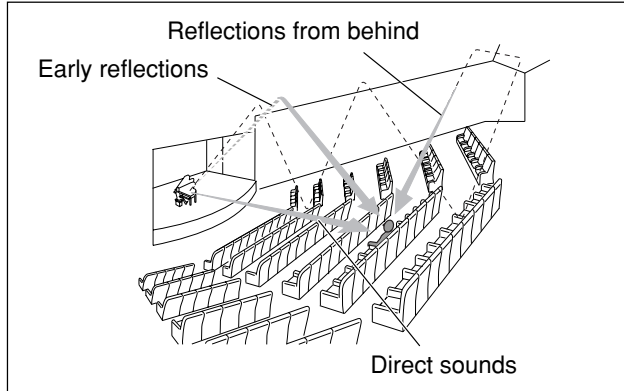

The DSP modes include the following modes:

- Digital Acoustic Processor (DAP) modes—HALL1, HALL2, LIVE CLUB, DANCE CLUB, PAVILION, THEATER1, THEATER2
- MONO FILM—Used for all types of 2-channel signals (including Dual Mono signal)
- All Channel Stereo mode (ALL CH STEREO)

When one of the DSP modes is activated, the DSP indicator lights up on the display.

Digital Acoustic Processor (DAP) modes

You can use the following DAP modes in order to reproduce a more acoustic sound field in your listening room.

HALL1	Reproduces the spatial feeling of a large shoebox-shaped hall designed primarily for classical concerts. (Its seating capacity is about 2000.)
HALL2	Reproduces the spatial feeling of a large vineyard-shaped hall designed primarily for classical concerts. (Its seating capacity is about 2000.)
LIVE CLUB	Reproduces the spatial feeling of a live music club with a low ceiling.
DANCE CLUB	Reproduces the spatial feeling of a rocking dance club.
PAVILION	Reproduces the spatial feeling of an exhibition hall with a high ceiling.
THEATER1	Reproduces the spatial feeling of a large theater where the seating capacity is about 600.
THEATER2	Reproduces the spatial feeling of a small theater where the seating capacity is about 300.

NOTE

When “THEATER1” or “THEATER2” is activated while playing back 2-channel analog or digital source, the built-in Dolby Pro Logic II decoder is activated and the  indicator lights up.

When using the DAP mode, the sounds come out of all the connected and activated speakers.

- If “SURROUND SPK” is set to “<NO>” in the speaker setting (see page 17), JVC’s original 3D-PHONIC processing (which has been developed to create the surround effect through the front speakers only) is used. The 3D-PHONIC indicator lights up on the display.

MONO FILM

In order to reproduce a more acoustic sound field in your listening room while viewing monaural sound video software (analog and 2-channel digital signals including Dual Mono signal), you can use this mode.

The surround effect will be added, and the sound localization of actor’s words will be improved.

This mode cannot be used for multi-channel digital signals.

When “MONO FILM” is used, sounds come out of all the connected (and activated) speakers.

- If “SURROUND SPK” is set to “<NO>” in the speaker setting (see page 17), JVC’s original 3D-PHONIC processing (which has been developed to create the surround effect through the front speakers only) is used. The 3D-PHONIC indicator lights up on the display.
- If incoming signals change from 2-channel digital signal to another digital signal type, “MONO FILM” is canceled and an appropriate Surround mode is activated.

All Channel Stereo mode (ALL CH STEREO)

This mode can reproduce a larger stereo sound field using all the connected (and activated) speakers. **This mode cannot be used if “SURROUND SPK” is set to “<NO>” in the speaker setting (see page 17).**

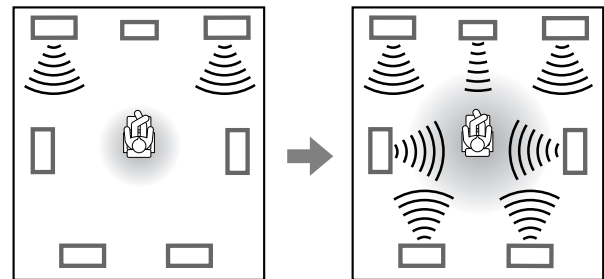

Sound reproduced from normal stereo

Sound reproduced from All Channel Stereo mode

Using the Surround/DSP modes

Available Surround/DSP modes vary depending on the speaker settings and the incoming signals. See the table below.

- The numbers inside the parentheses following the incoming signal type indicate the number of the front channels and that of the surround channels. For example, (3/2) indicates that the signals are encoded with three front signals (left/right/center) and two (stereo) surround signals.
- For EX/ES/PLIIX setting, see page 18.

Incoming Signal Type		EX/ES/PLIIX setting				
		AUTO	ON	PLIIX MOVIE	PLIIX MUSIC	OFF
Dolby Digital	Dolby Digital Surround EX	DOLBY D EX*3*5	DOLBY D EX*3	□□ D+PLIIX MOVIE*2,3	□□ D+PLIIX MUSIC*3	DOLBY DIGITAL
	Dolby Digital (3/2, 2/2)	DOLBY DIGITAL	DOLBY D EX*3	□□ D+PLIIX MOVIE*2,3	□□ D+PLIIX MUSIC*3	DOLBY DIGITAL
	Dolby Digital (3/1, 2/1, 3/0, 1/0)	DOLBY DIGITAL				
	Dolby Digital (Dual Mono)	DUAL MONO				
DTS	DTS-ES Discrete*1	DTS-ES DSCRT*3	DTS-ES DSCRT*3	DTS+PLIIX MOVIE*2,3	DTS+PLIIX MUSIC*3	DTS SURROUND
	DTS-ES Matrix*1	DTS-ES MATRIX*3	DTS-ES MATRIX*3	DTS+PLIIX MOVIE*2,3	DTS+PLIIX MUSIC*3	DTS SURROUND
	DTS (3/2, 2/2)*1	DTS SURROUND	DTS+NEO:6*3	DTS+PLIIX MOVIE*2,3	DTS+PLIIX MUSIC*3	DTS SURROUND
	DTS (3/1, 2/1, 3/0, 1/0)	DTS				
	DTS (Dual Mono)	DUAL MONO				
Analog/LINEAR PCM Dolby Digital (2/0)		PLIIX MOVIE*4/PLIIX MUSIC*4/NEO:6 CINEMA/NEO:6 MUSIC				PLII MOVIE/ PLII MUSIC/ NEO:6 CINEMA/ NEO:6 MUSIC

*1 DTS 96/24 processing is not applied when the EX/ES/PLIIX setting is activated. If you want to apply the processing, set the EX/ES/PLIIX setting to "OFF" (see page 18).

*2 When "S BACK OUT" is set to "<1SPK>," □□ D+PLIIX MOVIE is changed to DOLBY D EX and DTS+PLIIX MOVIE is changed to DTS+□□ EX.

*3 When "S BACK SPK" is set to "<NO>," Virtual Surround Back is activated for the modes and the VIRTUAL SB indicator lights up on the display.

*4 When "S BACK SPK" is set to "<NO>," PLIIX MOVIE is changed to PLII MOVIE and PLIIX MUSIC is changed to PLII MUSIC.

*5 For some Dolby Digital Surround EX software, Dolby Digital 5.1-channel reproduction ("DOLBY DIGITAL") may be applied even though you have selected "<AUTO>". In this case, select "<ON>" to apply "DOLBY D EX."

About the DSP modes

- The following DSP modes are available regardless of incoming signal type.
HALL1, HALL2, LIVE CLUB, DANCE CLUB, PAVILION, THEATER1, THEATER2
- If an incoming signal is a multi-channel (more than 2 channel) digital signal, "MONO FILM" is not available.
- If "SURROUND SPK" is set to "<NO>," "ALL CH STEREO" is not available.

Virtual Surround Back

This function creates the great surround effect from the behind as if you have connected the surround back speaker. The VIRTUAL SB (Surround Back) indicator lights up on the display.

If you have connected (and activated) the surround speakers, you can use Virtual Surround Back without connecting the surround back speaker.

Virtual Surround Back is activated when EX/ES/PLIIX is set to other than "<OFF>" and when playing back the software including the following signals:

- Dolby Digital Surround EX
- DTS-ES
- Dolby Digital or DTS with more than 4-channels

Activating the Surround/DSP modes

Available Surround/DSP modes vary depending on the speaker settings and the incoming signals. For details, see page 30.

Activating one of the Surround/DSP modes automatically recalls the memorized settings and adjustments.

- To adjust the speaker output level, see page 22.
- When activating one of the Surround/DSP modes, you can adjust CENTER TONE. (see page 24)
- When activating one of the Surround/DSP modes (except PLIIx MUSIC, PLII MUSIC, NEO:6 MUSIC, and ALL CH STEREO), you can adjust CENTER ALIGN. (see page 24)
- When activating "NEO:6 MUSIC," you can adjust CENTER GAIN. (see page 24)
- When activating the DSP mode (except ALL CH STEREO), you can adjust the following settings:
 - EFFECT (see page 23)
 - LIVENESS (see page 23)
 - ROOM SIZE (see page 23)
- When activating "PLIIx MUSIC" and "PLII MUSIC," you can adjust the following settings:
 - CENTER WIDTH (see page 24)
 - DIMENSION (see page 24)
 - PANORAMA (see page 23)

Selecting the Surround/DSP modes

From the remote control:

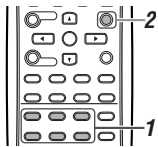

1 Select and play any source.

- Make sure you have selected the input mode (analog or digital) correctly.

2 Press SURROUND repeatedly to select the Surround/DSP mode you want.

Ex.: When "DOLBY DIGITAL" is selected for Dolby Digital multi-channel software:

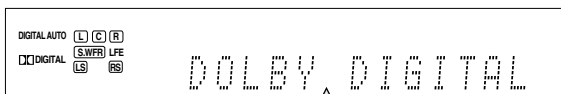

AUTO SURROUND*1 → Surround modes*2 →
 HALL1 → HALL2 → LIVE CLUB → DANCE CLUB
 → PAVILION → THEATER1 → THEATER2 →
 MONO FILM*3 → ALL CH STEREO*4 →
 SURROUND OFF → (Back to the beginning)

- *1 "AUTO SURROUND" is the initial setting.
- *2 Available Surround modes vary depending on the speaker settings and the incoming signals. For details, see page 30.
- *3 If an incoming signal is a multi-channel (more than 2 channel) digital signal, "MONO FILM" is not available.
- *4 If "SURROUND SPK" is set to "<NO>," "ALL CH STEREO" is not available.

To cancel Surround/DSP modes

Press SURROUND repeatedly so that "SURROUND OFF" appears on the display.

On the front panel:

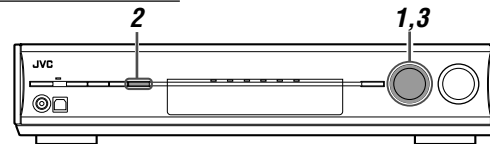

Before you start, remember...

There is a time limit in doing the following steps. If the setting is canceled before you finish, start from step 2 again.

1 Select and play any source.

- Make sure you have selected the input mode (analog or digital) correctly.

2 Press SURROUND.

MULTI JOG now works for selecting Surround/DSP modes.

3 Turn MULTI JOG to select the Surround/DSP mode you want.

Ex.: When "DOLBY DIGITAL" is selected for Dolby Digital multi-channel software:

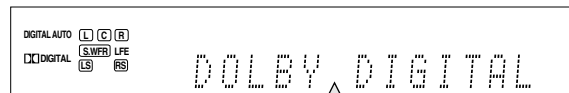

AUTO SURROUND*1 ↔ Surround modes*2 ↔
 HALL1 ↔ HALL2 ↔ LIVE CLUB ↔ DANCE CLUB
 ↔ PAVILION ↔ THEATER1 ↔ THEATER2 ↔
 MONO FILM*3 ↔ ALL CH STEREO*4 ↔
 SURROUND OFF ↔ (Back to the beginning)

- *1 "AUTO SURROUND" is the initial setting.
- *2 Available Surround modes vary depending on the speaker settings and the incoming signals. For details, see page 30.
- *3 If an incoming signal is a multi-channel (more than 2 channel) digital signal, "MONO FILM" is not available.
- *4 If "SURROUND SPK" is set to "<NO>," "ALL CH STEREO" is not available.

To cancel Surround/DSP modes

Turn MULTI JOG so that "SURROUND OFF" appears on the display.

When you select "AUTO SURROUND"

You can enjoy the Surround mode easily.

- For details about the Surround modes, see page 30.
- When "AUTO SURROUND" is activated, the AUTO SURR indicator lights up on the display.

How does "AUTO SURROUND" work?

- If a multi-channel signal comes in, an appropriate Surround mode will be selected automatically.
- If a Dolby Digital 2-channel with surround signal comes in, "PLIIx MOVIE" or "PLII MOVIE" will be selected.
- If a Dolby Digital 2-channel without surround signal comes in, "SURROUND OFF (stereo)" will be selected.
- If a Linear PCM signal comes in, "SURROUND OFF (stereo)" will be selected.

NOTE

"AUTO SURROUND" does not take effect in the following cases:
 – While playing an analog source,
 – While selecting one of the fixed digital decode mode—"DOLBY DIGITAL" or "DTS" (see page 13).

AV COMPU LINK remote control system

The AV COMPU LINK remote control system allows you to operate JVC's video components (TV, DVD player*, and VCR) through this receiver.

This receiver is equipped with the AV COMPU LINK-III, which has added a function to operate JVC's video components through the component video jacks. To use this remote control system, you need to connect the video components you want to operate, following the diagrams below and the procedures on page 33.

- Refer also to the manuals supplied with your video components.

* "DVD player" on pages 32 and 33 can be replaced with "DVD recorder."

Connections 1: AV COMPU LINK connection

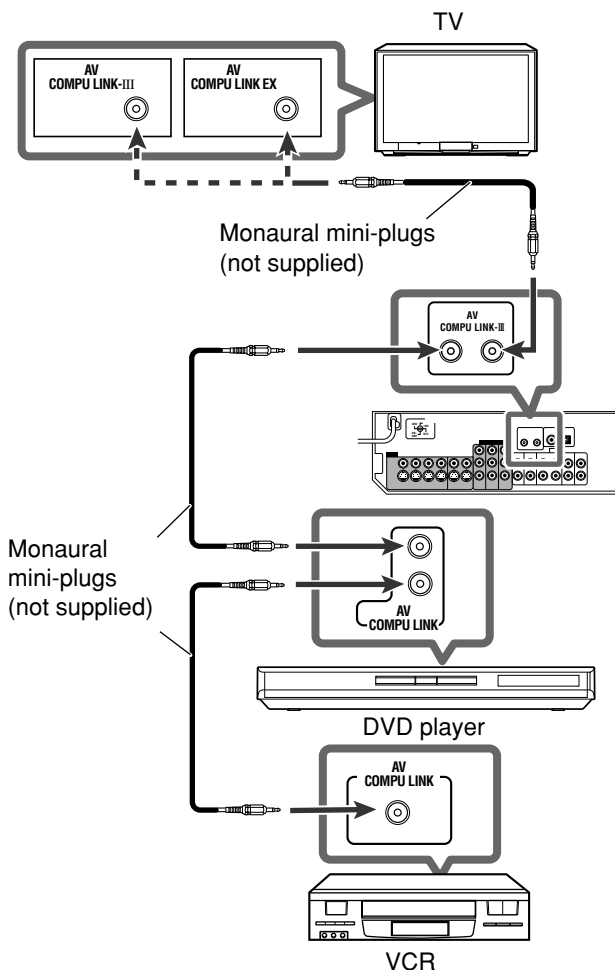

IMPORTANT:

The AV COMPU LINK remote control system cannot control the DBS tuner connected to the DBS IN jacks.

NOTES

- When connecting the receiver and a TV with the AV COMPU LINK EX terminal by using a component video cable, you cannot use Automatic selection of TV's input mode (see page 33).
- When connecting only the VCR and DVD player to this receiver, connect it directly to the receiver using cable with the monaural mini-plugs.
- You can connect only the TV with AV COMPU LINK EX or AV COMPU LINK-III terminal to the AV COMPU LINK-III terminal.

Connections 2: Video cable connection

This receiver is equipped with three types of the video terminals—composite video, S-video, and component video, and the signals coming into this receiver through one type of video terminals can output only through the terminal of the same type. So you need to connect the video components to this receiver using one of the following three ways.

- When using the AV COMPU LINK remote control system, set the video input for the DVD player and the VCR correctly (see "Selecting the component video input mode—DVD VIDEO IN/ VCR VIDEO IN/DBS VIDEO IN" on page 20); otherwise, the correct input for this receiver will not be selected on the TV.

Case 1:

When connecting the source equipment to the receiver through the S-video terminals, connect this receiver to the TV's video input 1 terminal using S-video cables.

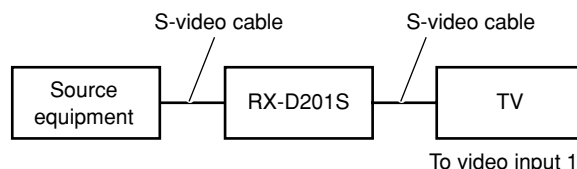

Case 2:

When connecting the source equipment to the receiver through the composite video jacks, connect this receiver to the TV's video input 2 terminal (composite video input) using composite video cables.

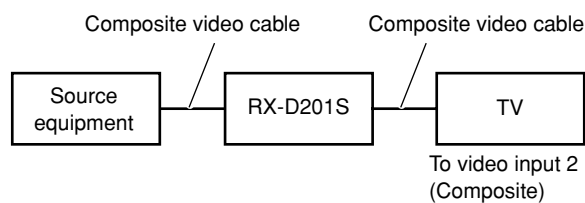

Case 3:

When connecting the source equipment to the receiver through the component video jacks, connect this receiver to the TV's video input 2 terminals (component video input) using component video cables.

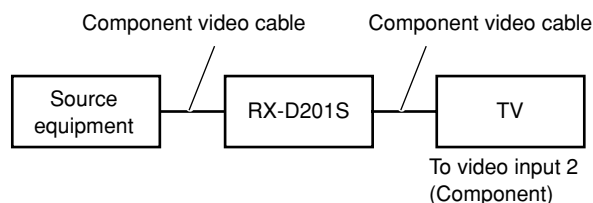

Connecting procedure

- 1 If you have already plugged your VCR, DVD player, TV, and this receiver into the AC outlets, unplug their AC power cords first.**
- 2 Connect your VCR, DVD player, TV, and this receiver as follows, using the cables with the monaural mini-plugs (not supplied).**
 - See "Connections 1" on the previous page.
- 3 Connect the audio input/output jacks on the VCR, DVD player, TV, and this receiver using the audio cables.**
 - See pages 7 to 9.
- 4 Connect the video input/output jacks on the VCR, DVD player, TV, and this receiver using the S-video cables, composite video cables, or component video cables.**
 - See "Connections 2" on the previous page.
- 5 Plug the AC power cords of the connected components and this receiver into the AC outlets.**
- 6 When turning on the TV for the first time after the AV COMPU LINK connection, turn the TV volume to the minimum using the TV volume control on the TV.**
- 7 Turn on other connected components first, then turn on this receiver.**
 - When turning on the VCR, use the remote control supplied with this receiver (press STANDBY/ON \odot /I VCR).

The AV COMPU LINK remote control system allows you to use the five basic functions listed below.

Remote control of the TV, DVD player, and VCR using this remote control

See pages 34 and 35 for details.

- Aim the remote control directly at the remote sensor on each component.

One-touch video play

Simply by inserting a video cassette without its safety tab into the VCR, you can enjoy the video playback without setting other switches manually. The receiver automatically turns on and changes the source to "VCR" (or "VCR DIGITAL").

The TV automatically turns on and changes the input mode to the appropriate position so that you can view the playback picture.

When you insert a video cassette with its safety tab, press the play (▶) button on the VCR or on the remote control. So, you can get the same result.

One-touch DVD play

Simply by starting playback on the DVD player, you can enjoy the DVD playback without setting other switches manually.

- When the DVD player is connected through the analog input jacks on this receiver (and analog input is selected), the receiver automatically turns on and changes the source to "DVR/DVD."
- When the DVD player is connected through the digital input terminal on this receiver (and digital input is selected), the receiver automatically turns on and changes the source to "DVR/DVD DGTL."

The TV automatically turns on and changes the input mode to the appropriate position so that you can view the playback picture.

Automatic selection of TV's input mode

- When you select "TV" (or "TV DIGITAL") as the source to play on the receiver, the TV automatically changes the input mode to the TV tuner so that you can watch TV.
- When you select "DVR/DVD" (or "DVR/DVD DGTL"), "VCR" (or "VCR DIGITAL"), or "DBS" (or "DBS DIGITAL") as the source to play on the receiver, the TV automatically changes the input mode to the appropriate position (either video input 1 or video input 2) so that you can view the playback picture.

NOTE

This function does not work when you connect this receiver and the TV with the AV COMPU LINK EX terminal using a component video cable. In this case, reconnect the TV referring to Case 1 or Case 2 on page 32.

Automatic power on/off

The TV, DVD player, and VCR turn on and off along with the receiver.

When you turn on the receiver;

- If the previously selected source is "TV" (or "TV DIGITAL") or "DBS" (or "DBS DIGITAL"), only the TV will turn on automatically.
- If the previously selected source is "DVR/DVD" (or "DVR/DVD DGTL"), the TV and DVD player will turn on automatically.
- If the previously selected source is "VCR" (or "VCR DIGITAL"), the TV and VCR will turn on automatically.

When you turn off the receiver, the TV, DVD player, and VCR will turn off.

NOTE

If you turn off the receiver while recording on the VCR, the VCR will not turn off, but continue recording.

Operating other JVC products

You can use the supplied remote control to operate not only this receiver but also other JVC products.

- Refer also to the manuals supplied with the other products.
 - Some JVC VCRs can accept two types of the control signals—remote codes “A” and “B.” This remote control can operate a VCR whose remote control code is set to “A.”
 - Some JVC DVD recorders can accept four types of the control signals. This remote control can operate a DVD recorder whose remote control code is set to the initial code. For details, refer to the manual supplied with the DVD recorder.
- To operate other products, aim the remote control directly at the remote sensor on the target product.

■ TV

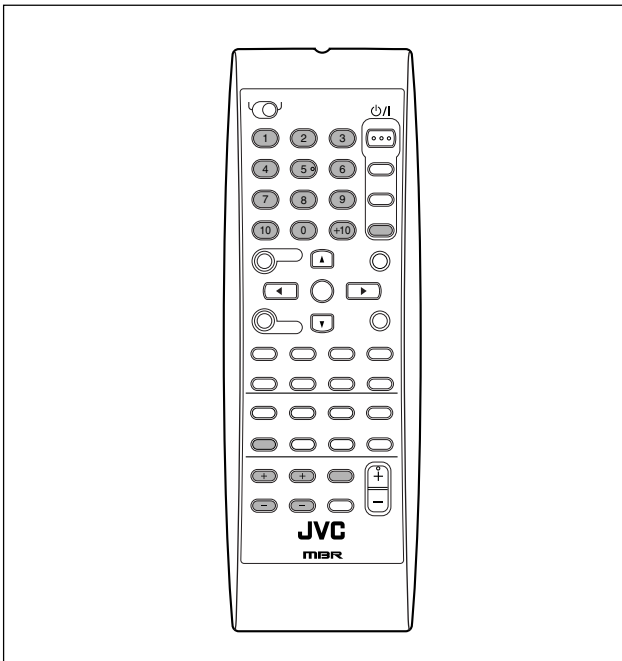

You can always perform the following operations:

TV VOLUME +/-:	Adjust the volume on the TV.
TV/VIDEO:	Change the input mode (either video input or TV tuner) on the TV.

After pressing TV, you can perform the following operations on the TV.

STANDBY/ON ϕ/I	Turn on or off the TV.
TV/DBS/CATV:	
CHANNEL +/-:	Change the channel numbers.
1 – 9, 0, 100+:	Select the channel numbers.
RETURN (10):	Switch between the previous channel and the current channel.

■ VCR

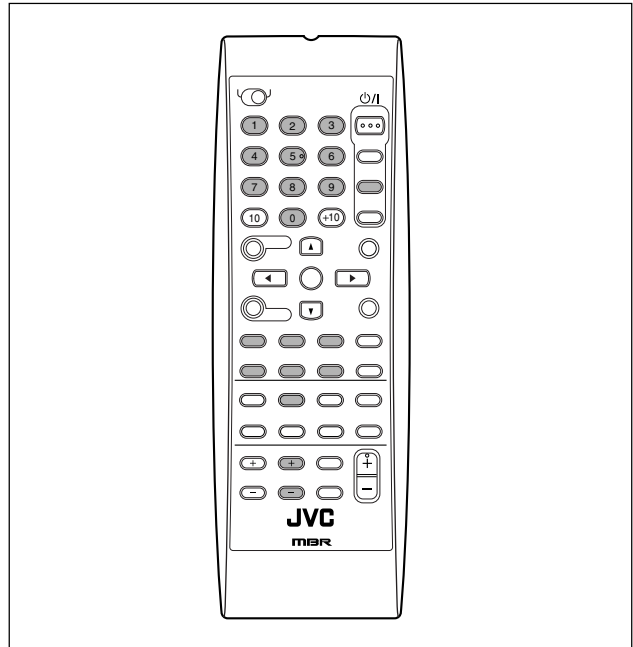

You can always perform the following operation:

STANDBY/ON ϕ/I	Turn on or off the VCR.
VCR:	

After pressing VCR, you can perform the following operations on the VCR.

CHANNEL +/-:	Change the channel numbers on the VCR.
▶:	Start playback.
■:	Stop playback.
 :	Pause playback. To release it, press ▶.
FF:	Fast-wind a tape.
REW:	Rewind a tape.
REC PAUSE:	Enter recording pause. To start recording, press this button then ▶.

■ DVD recorder or DVD player

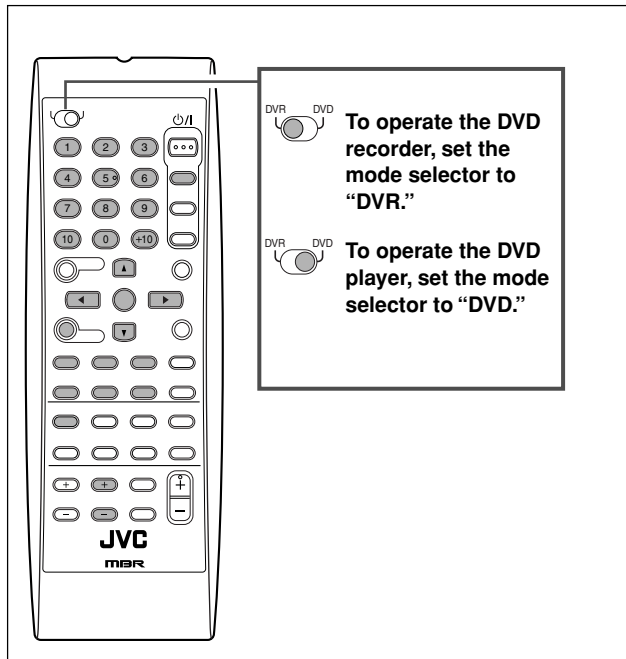

After setting the mode selector correctly, you can perform the following operations on the DVD recorder or DVD player.

See the instructions supplied with the DVD recorder or DVD player for details.

■ Changing the remote control code for DVD recorder

Some JVC DVD recorders can accept four types of the control signals. You can assign one of four codes to the remote control supplied with this receiver for operating your DVD recorder. For details, refer to the manual supplied with the DVD recorder.

Initial setting: 03

- 1 Set the mode selector to "DVR."
- 2 Press and hold **STANDBY/ON** **DVR/DVD**.
- 3 Press **DVR/DVD**.
- 4 Enter the remote control code you want using buttons 1 – 4, and 0.

EX.: To enter the code "2", press 0, then 2.

Code for DVR	Number to enter
1	01
2	02
3	03
4	04

- 5 Release **STANDBY/ON** **DVR/DVD**.

Now, the remote control code has been changed.

You can always perform the following operation:

STANDBY/ON **DVR/DVD**: Turn on or off the DVD recorder or DVD player.

After pressing **DVR/DVD**, you can perform the following operations on the DVD recorder and DVD player.

▶: Start playback.

■: Stop playback.

II: Pause playback. To release it, press **▶**.

▶▶: Skip to the beginning of the next chapter.

◀◀: Return to the beginning of the current (or previous) chapter.

▲/▼/▶/◀: Select an item on the menu screen.

MENU: Display the menu recorded on discs.

ENTER: Enter the selected item, channel number, chapter/title number, or track number (if required).

Only for DVD recorder operations:

CHANNEL +/-: Change the channel numbers.

1 – 9, 0: Select a channel number (while stopped) or a chapter/title number, track number (while playing back). Press **ENTER** to enter the number.

REC PAUSE: Enter recording pause. To start recording, press **▶**.

Only for DVD player operations:

1 – 10, 0, +10: Select a chapter/title number, track number, menu item, etc.

If these buttons do not function normally, use the remote control supplied with your DVD recorder or DVD player. Refer also to the manuals supplied with the DVD recorder or DVD player for details.

Operating other manufacturers' products

By changing the transmittable signals, you can use the supplied remote control to operate other manufacturers' products.

- Refer also to the manuals supplied with the other products.
- To operate those components with the remote control, first you need to set the manufacturers' codes each for the TV, VCR, CATV converter, DBS tuner, and DVD player.
- After replacing batteries of the remote control, set the manufacturers' codes again.
- All the functions may not be assigned to the buttons in some equipment.

□ Changing the transmittable signals for operating a TV

1 Press and hold STANDBY/ON \odot /I TV/DBS/CATV.

2 Press TV.

3 Enter the manufacturer's code using buttons 1 – 9, and 0.

See "Manufacturers' codes for TV" on the right.

4 Release STANDBY/ON \odot /I TV/DBS/CATV.

Now, you can perform the following operations on the TV.

TV VOLUME +/-: Adjust the volume on the TV.

TV/VIDEO: Change the input mode (either TV or VIDEO).

After pressing TV, you can perform the following operations on the TV.

STANDBY/ON \odot /I TV/DBS/CATV: Turn on or off the TV.

CHANNEL +/-: Change the channel numbers.

1 – 9, 0, 100+ (+10): Select the channel numbers.

See the instructions supplied with the TV for details.

5 After pressing TV, try to operate your TV by pressing STANDBY/ON \odot /I TV/DBS/CATV.

When your TV turns on or off, you have entered the correct code.

If more than one code is listed for your brand of TV, try each one until the correct one is entered.

Manufacturers' codes for TV

Manufacturer	Codes
JVC	01
Hitachi	10
Magnavox	02
Mitsubishi	03
Panasonic	04, 11
RCA	05
Samsung	12
Sanyo	13
Sharp	06
Sony	07
Toshiba	08
Zenith	09

Initial setting: 01

Manufacturers' codes are subject to change without notice. If they are changed, this remote control cannot operate the equipment.

❑ Changing the transmittable signals for operating a VCR

1 Press and hold STANDBY/ON \odot /I VCR.

2 Press VCR.

3 Enter the manufacturer's code using buttons 1 – 9, and 0.

See "Manufacturers' codes for VCR" on the right.

4 Release STANDBY/ON \odot /I VCR.

Now, you can perform the following operation on the VCR.

STANDBY/ON \odot /I Turn on or off the VCR.
VCR:

After pressing VCR, you can perform the following operations on the VCR.

CHANNEL +/-: Change the channel numbers on the VCR.

▶: Start playback.

■: Stop playback.

⏸: Pause playback.

FF: Fast-wind a tape.

REW: Rewind a tape.

REC PAUSE: Enter recording pause. To start recording, press this button then ▶.

See the instructions supplied with the VCR for details.

5 Try to operate your VCR by pressing STANDBY/ON \odot /I VCR.

When your VCR turns on or off, you have entered the correct code.

If more than one code is listed for your brand of VCR, try each one until the correct one is entered.

Manufacturers' codes for VCR

Manufacturer	Codes
JVC	01, 02, 03
Emerson	10, 22
Gold Star	11
Hitachi	04
Mitsubishi	12
NEC	21
Panasonic	07, 13
Philips	09
RCA	05, 06
Samsung	20
Sanyo	17, 18, 19
Sony	14, 15, 16
Zenith	08

Initial setting: 01

Manufacturers' codes are subject to change without notice. If they are changed, this remote control cannot operate the equipment.

❑ Changing the transmittable signals for operating a CATV converter or DBS tuner

- 1 Press and hold **STANDBY/ON** \odot /I TV/DBS/CATV.
- 2 Press **DBS**.
- 3 Enter the manufacturer's code using buttons 1 – 9, and 0.

See "Manufacturers' codes for CATV converter/DBS tuner" below.

4 Release **STANDBY/ON** \odot /I TV/DBS/CATV.

After pressing **DBS**, you can perform the following operations on the CATV converter or DBS tuner.

STANDBY/ON \odot /I TV/DBS/CATV:	Turn on or off the CATV converter or DBS tuner.
CHANNEL +/-:	Change the channel numbers on the CATV converter or DBS tuner.
1 – 10, 0, +10:	Select the channel numbers on the CATV converter or DBS tuner.

See the instructions supplied with the CATV converter or DBS tuner for details.

5 After pressing **DBS**, try to operate your CATV converter or DBS tuner by pressing **STANDBY/ON** \odot /I TV/DBS/CATV.

When your CATV converter or DBS tuner turns on or off, you have entered the correct code.

If more than one code is listed for your brand of CATV converter or DBS tuner, try each one until the correct one is entered.

Manufacturers' codes for CATV converter/DBS tuner

Manufacturer	Codes
Echostar (JVC)	01
G.I.	02, 03
Hamlin	10 – 13
Pioneer	08, 09
RCA	14
Scient	04, 05
Sony	15
Zenith	06, 07

Initial setting: 01

❑ Changing the transmittable signals for operating a DVD player

- 1 Set the mode selector to "DVD."
- 2 Press and hold **STANDBY/ON** \odot /I DVR/DVD.
- 3 Press **DVR/DVD**.
- 4 Enter the manufacturer's code using buttons 1 – 9, and 0.

See "Manufacturers' codes for DVD player" below.

5 Release **STANDBY/ON** \odot /I DVR/DVD.

Now, you can perform the following operation on the DVD player.

STANDBY/ON \odot /I DVR/DVD:	Turn on or off the DVD player.
---------------------------------------	--------------------------------

▶:	Start playback.
◀◀:	Return to the beginning of the current chapter (or fast-forward for some models).
▶▶:	Skip to the beginning of the next chapter (or fast-reverse for some models).
■:	Stop playback.
⏸:	Pause playback.
MENU:	Display the menu recorded on DVD VIDEO discs.
▲/▼/▶/◀:	Select an item on the menu screen.
ENTER:	Enter the selected item.
1 – 10, 0, +10:	Select the chapter number.

See the instructions supplied with the DVD player for details.

6 Try to operate your DVD player by pressing **STANDBY/ON** \odot /I DVR/DVD.

When your DVD player turns on or off, you have entered the correct code.

Manufacturers' codes for DVD player

Manufacturer	Codes
JVC	01
Panasonic	02
Philips	04
Pioneer	03
Sony	05
Toshiba	06
Yamaha	07

Initial setting: 01

NOTE

You cannot use this remote control to operate other manufacturers' DVD recorder.

Manufacturers' codes are subject to change without notice. If they are changed, this remote control cannot operate the equipment.

Troubleshooting

Use this chart to help you solve daily operational problems. If there are any problems you cannot solve, contact your JVC's service center.

	PROBLEM	POSSIBLE CAUSE	SOLUTION
Power	The power does not come on.	The power cord is not plugged in.	Plug the power cord into an AC outlet.
	The receiver turns off (enters standby mode).	Speakers are overloaded because of high volume.	1. Stop the playback source. 2. Turn on the receiver again, then turn the volume down.
		Speakers are overloaded because of a short circuit at the speaker terminals.	Check the speaker wiring. If speaker wiring is not short-circuited, contact your dealer.
		The receiver is overloaded because of a high voltage.	Consult your dealer after unplugging the power cord.
"OVER HEAT" flashes on the display, then the receiver turns off.	The receiver is overloaded because of high volume or long time usage.	Turn the volume down or turn off the receiver for a while and turn it on again. If the receiver turns off soon after doing solutions above, consult your dealer after unplugging the power cord.	
Sound	No sound from speakers.	Speaker signal cables are not connected.	Check speaker wiring, then reconnect if necessary (see page 6) after unplugging the power cord.
		Connections are incorrect.	Check the audio connections (see pages 7 to 11) after unplugging the power cord.
		An incorrect source is selected.	Select the correct source.
		Muting is activated.	Press MUTING to cancel the mute (see page 14).
	An incorrect input mode (analog or digital) is selected.	Select the correct input mode (analog or digital).	
Sound from one speaker only.	Speaker signal cables are not connected properly.	Check speaker wiring and reconnect if necessary (see page 6) after unplugging the power cord.	
Sounds are intermittently distorted by the outside noise such as a lightning discharge.	When you use the digital coaxial connection, the sounds may be intermittently distorted by the outside noise such as a lightning discharge but the sound will be restored automatically.	This is not a malfunction.	
Remote control	Remote control does not operate as you intend.	The remote control is not ready for your intended operation.	Set the mode selector correctly, then press the corresponding source selecting button or SOUND before operation.
	Remote control does not work.	There is an obstruction hiding the remote sensor on the receiver.	Remove the obstruction.
		Batteries are weak.	Replace batteries.
Tuner	Continuous hiss or buzzing during FM reception.	The mode selector is set to the incorrect position.	Set the mode selector to the proper position.
		Incoming signal is too weak.	Connect an outdoor FM antenna or contact your dealer.
		The station is too far away.	Select another station.
		The wrong antenna is being used.	Check with your dealer to be sure you have the correct antenna.
	Antennas are not connected properly.	Check the connections.	
Occasional cracking noise during FM reception.	Ignition noise from automobiles.	Move the antenna farther from automobile traffic.	

Specifications

Designs and specifications are subject to change without notice.

Amplifier

Output Power

At stereo operation:

Front channels: 100 W* per channel, min. RMS, driven into 6 Ω at 1 kHz with no more than 0.8% total harmonic distortion.

At surround operation:

Front channels: 100 W* per channel, min. RMS, driven into 6 Ω at 1 kHz with no more than 0.8% total harmonic distortion.

Center channel: 100 W*, min. RMS, driven into 6 Ω at 1 kHz, with no more than 0.8% total harmonic distortion.

Surround channels: 100 W* per channel, min. RMS, driven into 6 Ω at 1 kHz, with no more than 0.8% total harmonic distortion.

Surround back channels: 100 W* per channel, min. RMS, driven into 6 Ω at 1 kHz, with no more than 0.8% total harmonic distortion.

* Measured on AC 110 V, 127 V, 220 V, and 240 V.

Audio

Audio Input Sensitivity/Impedance:

DVR/DVD, VCR, DBS, TV: 270 mV/47 kΩ

Audio Input (DIGITAL IN)*:

Coaxial: DIGITAL IN 1(DVR/DVD): 0.5 V(p-p)/75 Ω

Optical: DIGITAL IN 2(DBS): -21 dBm to -15 dBm (660 nm ±30 nm)

USB: USB DIGITAL

* Corresponding to Linear PCM, Dolby Digital, and DTS (with sampling frequency—32 kHz, 44.1 kHz, 48 kHz).

Audio Output Level:

DVR, VCR: 270 mV

Signal-to-Noise Ratio (*66 IHF/DIN): 80 dB/62 dB

Frequency Response (6 Ω): 20 Hz to 20 kHz (±1 dB)

Bass Boost: +4 dB ±1 dB at 100 Hz

Equalization (at DSP operation):

Center frequency: 63 Hz, 250 Hz, 1 kHz, 4 kHz, 16 kHz

Control range: ±8 dB

Video

Video Input Sensitivity/Impedance:

Composite video: DVR/DVD, VCR, DBS: 1 V(p-p)/75 Ω

S-video: DVR/DVD, VCR, DBS:

Y (luminance): 1 V(p-p)/75 Ω

C (chrominance, burst): 0.3 V(p-p)/75 Ω

Component: DVR/DVD, VCR (DBS):

Y (luminance): 1 V(p-p)/75 Ω

PB, PR: 0.7 V(p-p)/75 Ω

Video Output Level/Impedance:

Composite video: DVR, VCR, MONITOR OUT: 1 V(p-p)/75 Ω

S-video: DVR, VCR, MONITOR OUT:

Y (luminance): 1 V(p-p)/75 Ω

C (chrominance, burst): 0.3 V(p-p)/75 Ω

Component: MONITOR OUT:

Y (luminance): 1 V(p-p)/75 Ω

PB, PR: 0.7 V(p-p)/75 Ω

Synchronization: Negative

FM tuner (IHF)

Tuning Range: 87.50 MHz to 108.00 MHz

Usable Sensitivity:

Monaural: 12.8 dBf (1.2 μV/75 Ω)

50 dB Quieting Sensitivity:

Monaural: 16.0 dBf (1.7 μV/75 Ω)

Stereo: 37.5 dBf (20.5 μV/75 Ω)

Stereo Separation at REC OUT: 35 dB at 1 kHz

AM tuner

Tuning Range: 531 kHz to 1 710 kHz (at 9 kHz intervals)
530 kHz to 1 710 kHz (at 10 kHz intervals)

General

Power Requirements: AC 110 V/127 V/220 V/230 V – 240 V ~, adjustable with the voltage selector, 50 Hz/60 Hz

Power Consumption: 180 W (at operation)
0.9 W (in standby mode)

Dimensions (W x H x D): 435 mm x 91.5 mm x 360 mm

Mass: 6.7 kg

Mains (AC) Line Instruction (not applicable for Europe, U.S.A., Canada, Australia, and U.K.)

主 (AC) 电源线路说明 (不适用于欧洲、美国、加拿大、澳洲及英国型号)

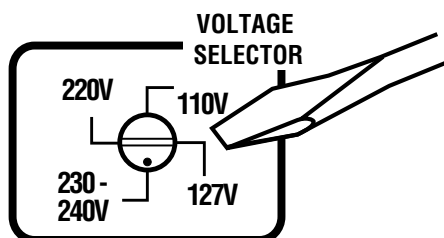
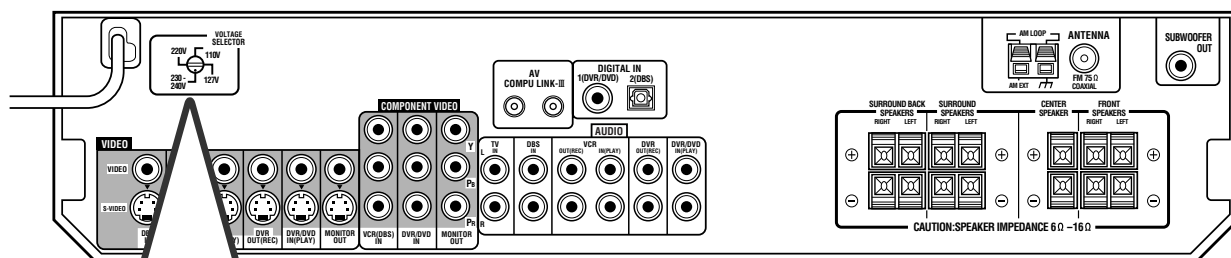

CAUTION for mains (AC) line

BEFORE PLUGGING IN, do check that your mains (AC) line voltage corresponds with the position of the voltage selector switch provided on the outside of this equipment and, if different, reset the voltage selector switch, to prevent from a damage or risk of fire/electric shock.

有关主(AC)电源线路的注意事项

接插电源以前，务请检查当地的主 (AC) 电源线路电压是否和位于本机外面的电压选择开关设定的位置一致。如果不一致，即重新设定电压选择开关使符合当地电压，以免损坏机器或引起火灾/触电的危险。

JVC